

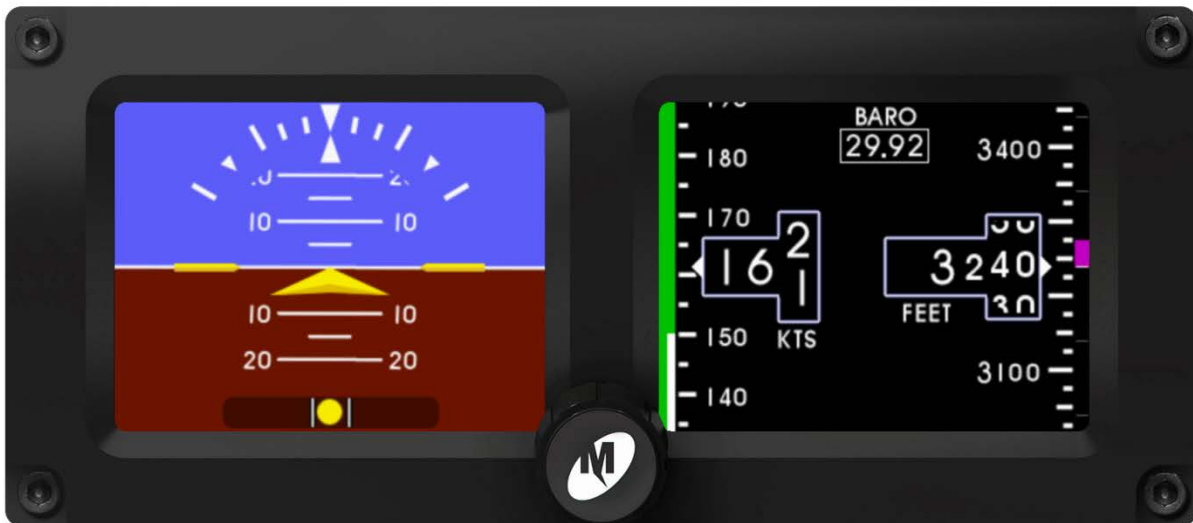

**INSTALLATION MANUAL AND
OPERATING INSTRUCTIONS**

**MODEL MD302-() SERIES
STANDBY ATTITUDE MODULE**



Mid-Continent Instrument Co., Inc.
dba Mid-Continent Instruments and Avionics
9400 E. 34th Street N.
Wichita, KS USA 67226
(800) 821-1212
(316) 630-0723

Manual Number 9017782
Rev B, October 31, 2012

FOREWORD

This manual provides information intended for use by persons who, in accordance with current regulatory requirements, are qualified to install this equipment. If further information is required, please contact:

Mid-Continent Instruments and Avionics
Attn: Customer Service Dept.
9400 E. 34th St. N.
Wichita, KS 67226 USA
Phone 316-630-0101
Fax 316-630-0723
www.mcico.com

We welcome your comments concerning this manual. Although every effort has been made to keep it free of errors, some may occur. When reporting a specific problem, please describe it briefly and include the manual part number, the paragraph/figure/table number, and the page number. Send your comments to:

Mid-Continent Instruments and Avionics
Attn: Customer Service Dept.
9400 E. 34th St. N.
Wichita, KS 67226 USA
Phone 316-630-0101
Fax 316-630-0723

©Copyright 2012
Mid-Continent Instrument Co., Inc.

REVISION HISTORY

Rev	Date	Approved	Detail
1	09/10/12	BAW	Engineering release.
A	10/02/12	BAW	Initial release.
B	10/31/12	BAW	Updates implemented.

Table of Contents

SECTION 1	GENERAL DESCRIPTION	6
1.1	INTRODUCTION	6
1.2	SYSTEM OVERVIEW	7
1.2.1	PRE-FLIGHT MODE	7
1.2.2	FLIGHT MODE	7
1.2.3	EMERGENCY MODE	9
1.2.4	CONFIGURATION MODE	9
1.3	TECHNICAL SPECIFICATIONS	10
1.3.1	ELECTRICAL ATTRIBUTES	10
1.3.2	PHYSICAL ATTRIBUTES	10
1.3.3	PERFORMANCE LIMITS	10
1.3.4	QUALIFICATIONS	10
SECTION 2	INSTALLATION	12
2.1	GENERAL INFORMATION	12
2.2	PARTS LIST	12
2.3	EQUIPMENT LOCATION	12
2.4	LIMITATIONS	14
2.5	CABLE HARNESS	15
2.5.1	WIRE GAUGE SELECTION	15
2.5.2	CONFIGURATION MODULE	15
2.6	PITOT / STATIC CONNECTIONS	18
2.7	MOUNTING	18
2.8	INSTALLATION COMPLETION	18
SECTION 3	OPERATION	21
3.1	USER INTERFACE	21
3.2	PRE-FLIGHT MODE	21
3.3	FLIGHT MODE	22
3.3.1	MAJOR FUNCTIONS	23
3.3.1.1	ATTITUDE OPERATION	23
3.3.1.2	ALTITUDE OPERATION	24
3.3.1.3	AIRSPEED OPERATION	25
3.3.1.4	SLIP OPERATION	26
3.3.2	OPTION SETTINGS	27
3.3.2.1	MENU OPERATION	27
3.3.2.2	ALT UNITS	28
3.3.2.3	BARO UNITS	28
3.3.2.4	SYMBOL	28
3.3.2.5	ATT MASK	29
3.3.2.6	ALT TREND	29
3.3.2.7	POWER OFF	30
3.3.2.8	REVIEW CONFIG	30
3.3.2.9	EXIT MENU	31
3.3.3	BRIGHTNESS ADJUSTMENT	31
3.4	EMERGENCY OPERATION	31
3.4.1	IN FLIGHT	31
3.4.2	ON THE GROUND	32

SECTION 4	CONFIGURATION SETUP	33
4.1	CONFIGURATION MODE/MENU	33
4.2	CONFIGURE DISPLAY	34
4.2.1	ROLL DISPLAY.....	35
4.2.2	AIRSPPEED UNITS.....	35
4.2.1	DISPLAY ORIENTATION	36
4.3	CONFIG DIMMING	36
4.3.1	DIMMING CONTROL.....	37
4.3.2	DIMMING CURVE.....	37
4.4	CONFIGURE AIRCRAFT	38
4.4.1	PANEL TILT.....	39
4.4.2	RANGE MMO	39
4.4.3	RANGE MARKINGS.....	40
4.5	CONFIGURATION MODE ACTIONS	41
4.5.1	UPDATE SOFTWARE.....	41
4.5.2	ARINC SPEED.....	41
4.5.3	ACCEPT CHANGES	42
4.5.4	CANCEL CHANGES	42
SECTION 5	CONFORMANCE	43
5.1	INSTRUCTIONS FOR CONTINUED AIRWORTHINESS	43
5.1.1	PRESSURE SYSTEM AND ALTIMETER VERIFICATION	43
5.1.2	SOFTWARE UPGRADES.....	43
5.1.3	BATTERY REPLACEMENT	43
5.1.4	TROUBLESHOOTING.....	43
5.2	ENVIRONMENTAL QUALIFICATION STATEMENT	47

SECTION 1 GENERAL DESCRIPTION

1.1 INTRODUCTION

The model MD302 series Standby Attitude Module is a self-contained situational awareness instrument that provides aircraft attitude, altitude, airspeed and slip indication. The compact and innovative design of the MD302 is specifically developed for maximum flexibility for installation in retrofit or modern instrument panel. Its size, extra-wide viewing angle and AnyWay selectable orientation allows it to be installed almost anywhere in the instrument panel and in less space than traditional 2-inch mechanical standby or primary flight instruments.

Regardless of the aircraft you're flying, the MD302 is a great fit. With a 10 to 32 volt DC input range, the unit will work with 14 or 28V aircraft electrical buses and the selectable lighting input allows operation with 5, 14 or 28V lighting systems. The operation and certification of the MD302 make it well suited for Part 23 and 25 fixed-wing applications as well as Part 27 and 29 rotorcraft.

The MD302 provides critical flight and situational data to the pilot and crew under any circumstances you're likely to encounter. The design is built around a solid-state electronic sensor array for high reliability and contains an integral and rechargeable Nanophosphate[®] lithium-ion battery that can power the unit for up to two hours if main aircraft power is lost. The dual, high-resolution LCD display uses smooth graphics, daylight-readable brightness, and a configurable lighting response curve to ensure optimal visibility in all conditions.

The user interface of the product allows for simple, intuitive operation using a single push-and-turn knob that easily navigates through the user options and menu screens. The interactivity of the unit means that it can receive and transmit ARINC 429 data communications. Functional outputs of attitude, altitude, and airspeed can be used for monitoring or backup information while baro input data can be received that will synchronize the baro setting with the primary system to eliminate redundant task loading for the pilot.

The MD302 is an excellent complement to your avionics suite as a reliable and state-of-the-art instrument that is an essential part of any instrument panel.

1.2 SYSTEM OVERVIEW

The MD302 has four specific modes of operation. They are:

- Pre-flight Mode
- Flight Mode
- Emergency Mode
- Configuration Mode

The following sections will briefly introduce each mode with further details provide within Sections 3 and 4 of this manual.

1.2.1 PRE-FLIGHT MODE

In Pre-flight Mode, power is applied to the unit and the introduction screen appears during startup with the information shown in Figure 1.1.



FIGURE 1.1

1.2.2 FLIGHT MODE

In Flight Mode, the unit operates normally by displaying attitude, altitude, airspeed and slip information as shown in Figure 1.2.

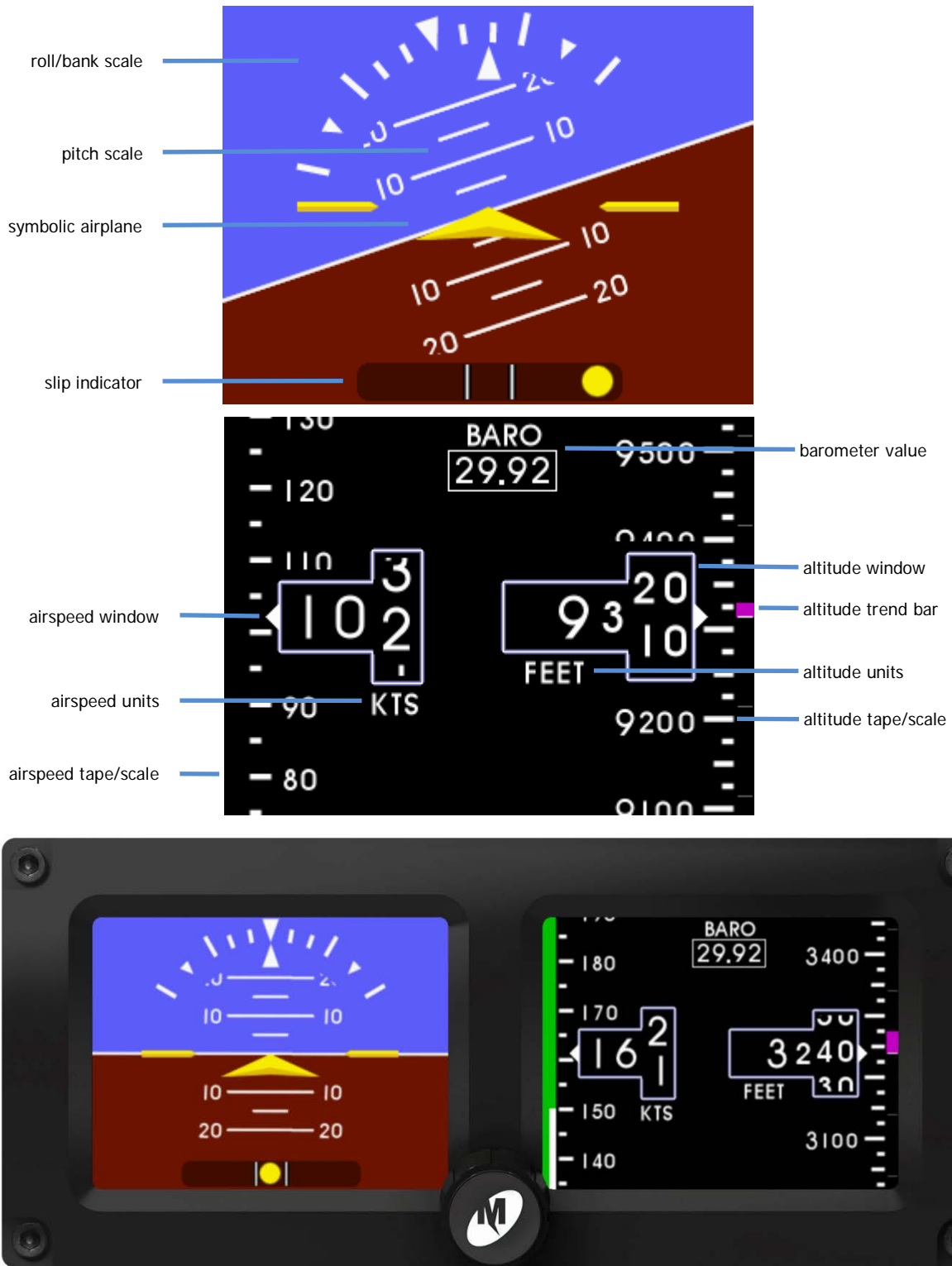

FIGURE 1.2

1.2.3 EMERGENCY MODE

In Emergency Mode, aircraft power to the instrument has been lost and the unit continues to operate in Flight Mode utilizing power from the internal battery. The battery icon is displayed as shown in Figure 1.3.

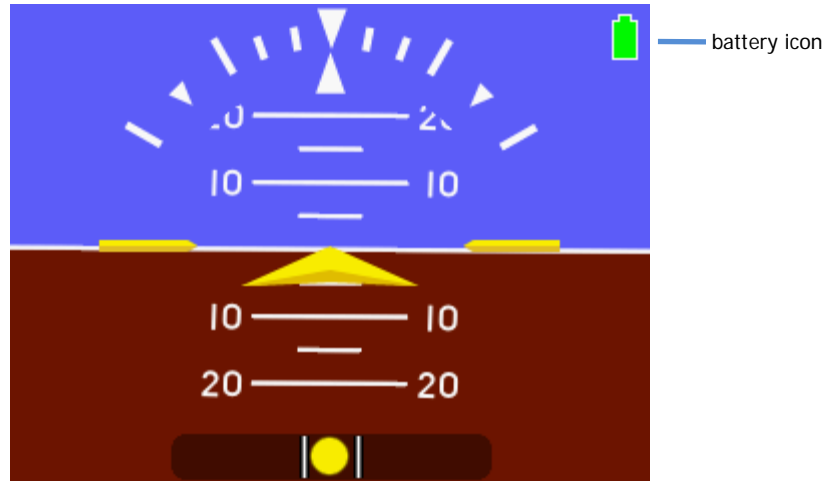

FIGURE 1.3

1.2.4 CONFIGURATION MODE

In Configuration Mode, an authorized installer can change and set the appropriate configuration values that are specific to the aircraft. These also include user preferences that are not available during flight and certain maintenance functions as well. The top level menu in Configuration Mode is shown in Figure 1.4.

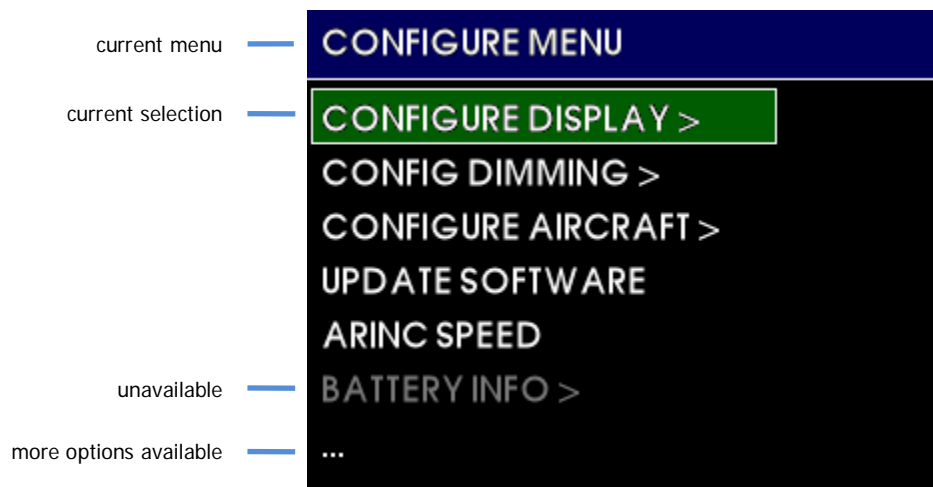

FIGURE 1.4

1.3 TECHNICAL SPECIFICATIONS

1.3.1 ELECTRICAL ATTRIBUTES

Characteristics:	
Input Voltage:	10-32 VDC
Input Power:	(nominal) 4 watts (0.15A @ 28VDC)
	(maximum) 25 watts max (when charging and heating battery)
Lighting Input:	5.14, or 28VDC or automatic photocell control
Input Data:	barometer synchronization via ARINC 429 (see Table 1.5)
Output Data:	attitude, altitude, airspeed via ARINC 429 (see Table 1.5)
	discrete valid signal to ground; invalid signal is open (pin 2)

TABLE 1.1

1.3.2 PHYSICAL ATTRIBUTES

Characteristics:	
Weight:	1.6 pounds (0.73 kg)
Dimensions: (without connectors, mates, & knob)	Bezel: 2.37" x 5.50" x 0.33" (HxWxD) Chassis: 2.31" x 3.16" x 4.82" (HxWxD)
Mating Connectors:	15-pin D-Sub with Configuration Module, MCIA p/n 9017275 Pneumatic fittings, MCIA p/n 9017642
Mounting:	Panel mount from front; uses (4) #6-32 cap screws and MCIA p/n 9017490-2 Nutplate (included)

TABLE 1.2

1.3.3 PERFORMANCE LIMITS

Characteristics:	
Attitude:	Pitch Angle No limits (360° +)
	Pitch Rate 300° per second max
	Roll Angle No limits (360° +)
	Roll Rate 300° per second max
Altitude:	Range -1,500 to +55,000 feet (available in meters)
	Barometer 28.00 to 31.00 inches of mercury (available in inHg/mB/hPa)
Air Speed:	Range 20 to 500 knots (available in mph or kph)

TABLE 1.3

1.3.4 QUALIFICATIONS

Specifications:	
Certifications: (PENDING)	FAA TSO-C2d (Type B), C3e, C4c, C10b, C106, C113a, C179a
Environmental Qualification:	RTCA DO-160G Environmental Category (F1)(S2)AB(RBB1)XXXXXXZ(ZXX)AZ(ZC)[WF]P[B3H33]XXAX
Software Qualification:	RTCA DO-178B, Design Assurance Level A
Complex Hardware Qualification:	RTCA DO-254, Design Assurance Level A

TABLE 1.4

ARINC DATA LABELS

All labels are defined as Equipment ID 038 in BNR format.
High and Low speed options are configurable. See Section 3.4.

ARINC 429 Input		Speed	
Label	Description	High	Low
203	altitude (rel 29.92)	x	x
204	baro altitude	x	x

ARINC 429 Output		Speed	
Label	Description	High	Low
203	altitude (rel 29.92)	x	x
204	baro altitude	x	x
212	altitude rate	x	x
215	impact pressure	x	x
217	static pressure	x	x
324	pitch attitude	x	x
325	roll attitude	x	x
326	body pitch rate	x	
327	body roll rate	x	
330	body yaw rate	x	
331	body longitudinal acceleration	x	
332	body lateral acceleration	x	
333	body normal acceleration	x	
336	inertial pitch rate	x	
337	inertial roll rate	x	
340	inertial yaw rate	x	
364	vertical acceleration	x	
377	specific equipment id	x	x

TABLE 1.5

SECTION 2 INSTALLATION

2.1 GENERAL INFORMATION

IMPORTANT: READ THIS ENTIRE SECTION PRIOR TO STARTING INSTALLATION!

This section contains interconnect diagrams, mounting dimensions and other information pertaining to the installation of the MD302 Digital Flight Instrument. After installation of cabling and before installation of the equipment, ensure that power is applied only to the pins specified in the interconnect diagram.

2.2 PARTS LIST

When unpacking this equipment, make a visual inspection for evidence of any damage that may have incurred during shipment. The following parts should be included:

<u>Item Description</u>	<u>MCIA Part Number</u>
a. MD302 Digital Flight Instrument	6420302-()
b. Installation Manual –	9017782
c. Connector Kit –	9017646
i. Nutplate	9017490-2
ii. Pneumatic Connector (x2)	9017642
iii. Screw, Hex, 6-32x5/8 (x4)	90-620-52011
iv. Screw, Flat, 2-56x1/4 (x2)	90-208-10011
v. Configuration Module	9017275
1. 15-pin D-Sub	
2. Backshell	
3. Backshell Cover	
4. Printed Circuit Board Assembly	
5. Screw, Flat, 2-56x1/4 (x2)	
6. Screw, 4-40x3/16 (x4)	

2.3 EQUIPMENT LOCATION

The MD302 Standby Attitude Module is designed primarily to be installed in the instrument panel of the aircraft. However, within the limitations of the environmental qualifications, other locations may be acceptable when considered within the context of the specific application and with the appropriate installation certification.

The MD302 has an extra wide viewing angle and AnyWay™ selectable orientation that allows for flexible installation locations and options. The unit can be mounted vertically (knob left or knob right) or horizontally. Once installed, the display orientation can be selected to match the installation. See Figure 2.1. However, be sure to consider appropriate field-of-view in regards to pilot and/or co-pilot visibility and accessibility when selecting a location to install the MD302. Note: when installing in vertical orientation, choose the knob position based on whether or not the pilot's hand will obscure the display during operation.

Additionally, consider what equipment is behind the panel which may impede the installation of the MD302. Clearance for the unit as well as its electrical and pneumatic connections and routing must be allowed. Be aware of routing cables near other electronics or with other wire bundles that may be susceptible to high energy flow. Avoid sharp bends in cabling or hoses and routing near aircraft control cables. Also avoid proximity and contact with aircraft structures, avionics equipment, heat sources or other obstructions that could chafe or damage wires or hoses during flight and cause undesirable effects.

No external cooling is required.



**FIGURE 2.1
INSTALLATION ORIENTATION OPTIONS**

2.4 **LIMITATIONS**

The conditions and tests for TSO approval of this article are minimum performance standards. Those installing this article, on or in a specific type or class of aircraft, must determine that the aircraft installation conditions are within the TSO standards, specification of the article, and deviations as listed above. TSO articles must have separate approval for installation in an aircraft. The article may be installed only according to 14 CFR part 43 or the applicable airworthiness requirements.

There are some portions of these TSOs which do not apply to our product or represent outdated requirements. These items are highlighted below and have been submitted to and approved by the FAA as deviations to the TSO certifications of the product.

FAA TSO-C2d: Airspeed Instruments

- instrument is not labeled with "Airspeed" or "IAS"

FAA TSO-C3e: Turn and Slip Instrument

- instrument does not provide rate-of-turn functionality

FAA TSO-C4c: Bank and Pitch Instruments

- dielectric strength/insulation resistance does not apply due to electronic components between chassis and connector pins

FAA TSO-C10b: Altimeter, Pressure Actuated, Sensitive Type

- graduation increments are every 25 feet instead of 20 feet

FAA TSO-C179a: Permanently Installed Rechargeable Lithium Cells, Batteries and Battery Systems

- dielectric strength/insulation resistance does not apply due to electronic components between chassis and connector pins

2.5 CABLE HARNESS

Construct the cable harness with regards to the instructions below and using the Connector Pinout of Table 2.1 and Figure 2.2 and Configuration Module Assembly of Figure 2.3. Installers should follow industry-accepted practices regarding aircraft wiring and applicable regulatory and advisory requirements and guidance.

Refer to Section 2.3: Equipment Location in regards to routing precautions.

2.5.1 WIRE GAUGE SELECTION

Wire gauge should be 22 AWG. Use of PTFE, ETFE, TFE, Teflon, or tefzel insulated wire is recommended for aircraft use per MIL-DTL-16878 or equivalent for the connections as noted below. Additionally, for data signals associated with ARINC 429 inputs and outputs, shielded twisted pair wiring per M27500 or equivalent is recommended (pin pairs 3/8 and 12/13).

2.5.2 CONFIGURATION MODULE

The supplied custom configuration module is required for proper installation and operation of the MD302 unit. The functions associated with the 15-pin D-subminiature connector are identified as follows:

15-pin D-Sub Connector

Pin No.	Description	Pin No.	Description
1	+10-32VDC Input	8	ARINC Out A
2	Valid Signal Out	9	Reserved
3	ARINC Out B	10	Config Module Clock
4	Reserved	11	Reserved
5	Config Module Power	12	ARINC In A
6	Power Return / Ground	13	ARINC In B
7	Lighting Bus Input	14	Config Module Data
		15	Config Module Return

TABLE 2.1

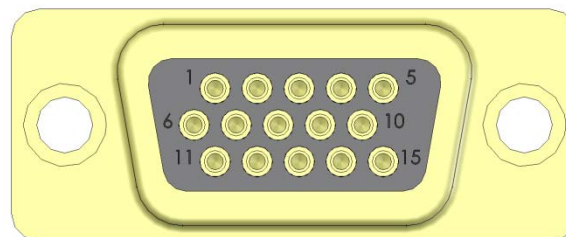

FIGURE 2.2
VIEW FROM REAR OF MATING CONNECTOR

To assembly the aircraft cable harness and Configuration Module refer to the following instructions and Figure 2.3:

- 1) Install a pin/socket as supplied in the Connector Kit using an appropriate crimping tool for each wire in the aircraft cable harness. Be sure to make the harness long enough to remove the unit from the front of the panel without stressing the harness (approx. 8" longer than required to reach the unit connector).
- 2) Braids from shielded wires should separate from the wire conductors and pulled back from the pin/socket termination approximately 2" and gathered together.
 - a. NOTE: Additional chafe protection, such as heat shrink or nylon wire braid is recommended over the bundle (not including the shields) to prevent wear when installed in the cable clamp.
- 3) Insert the pins of the cable harness into the rear of the 15-pin D-Sub connector (Item 4) per Table 2.1 and Figure 2.2 using an appropriate pin insertion tool.

NOTE: The Configuration Module PC Board Assembly contains sensitive electronics that can be damaged by electrostatic discharge (ESD). Appropriate precautions should be applied prior to handling this component.

- 4) Insert the pins of the Configuration Module PC Board Assembly (Item 3) into their corresponding locations as noted below using an appropriate pin insertion tool.
 - a. The wires coming from the Configuration Module PC Board Assembly are marked as follows on the circuit board: TP1, TP2, TP3, TP4.
 - b. With the D-Sub oriented up (pin locations 1-5 on top), orient the Configuration Module PC Board Assembly with the electronic parts facing UP prior to pin insertion.
 - c. Install each pin into the rear of the D-Sub connector as follows:
 - TP1 = config return = pin 15
 - TP2 = config data = pin 14
 - TP3 = config clock = pin 10
 - TP4 = config power = pin 5
- 5) Install the D-Sub Backshell Spring (Item 5) as shown.
- 6) Place the D-Sub Slide Lock (Item 6) over the D-Sub connector.
- 7) Install the D-Sub connector with Slide Lock and cable harness attached into the Backshell (Item 9) and secure with (2) screws (Item 8). Verify that the Backshell Spring is between the Slide Lock and Backshell. Move the Slide Lock back and forth to verify free movement.
- 8) Route the aircraft wire harness bundle (excluding shield braids) between the two halves of the Cable Strain Relief Clamp (Item 7). The Clamp should be placed over the chafe protection installed in Step 2 (if used).
- 9) Loosely connect the two halves of the Cable Strain Relief Clamp with (2) screws (Item 8).
- 10) Place the Cable Strain Relief Clamp in the Backshell as shown.
- 11) Bend the wires of the Configuration Module PC Board Assembly 180 degrees so that the PC Board has its electrical components facing down as shown. Be careful not to place excess strain on the solder connections between the wires and the PC Board.
- 12) Capture the Configuration Module PC Board Assembly into the Backshell by placing the Backshell Cover (Item 2) on top of the Backshell.
- 13) Secure the Backshell Cover onto the Backshell using (2) Screws (Item 9).
- 14) Bundle the exposed shield braids and secure them to either side of the rear of the Backshell, along with a connection to aircraft chassis ground, in the threaded holes using the one or both of the remaining two 4-40 screws provided in the connector kit. Use of a ring terminal (not included) may be useful.
- 15) The completed assembly should look as shown. Verify that the Slide Lock operates freely and that no wires are pinched, nicked, or otherwise damaged.
- 16) Verify that power and ground signals are installed appropriately before connecting to the unit.

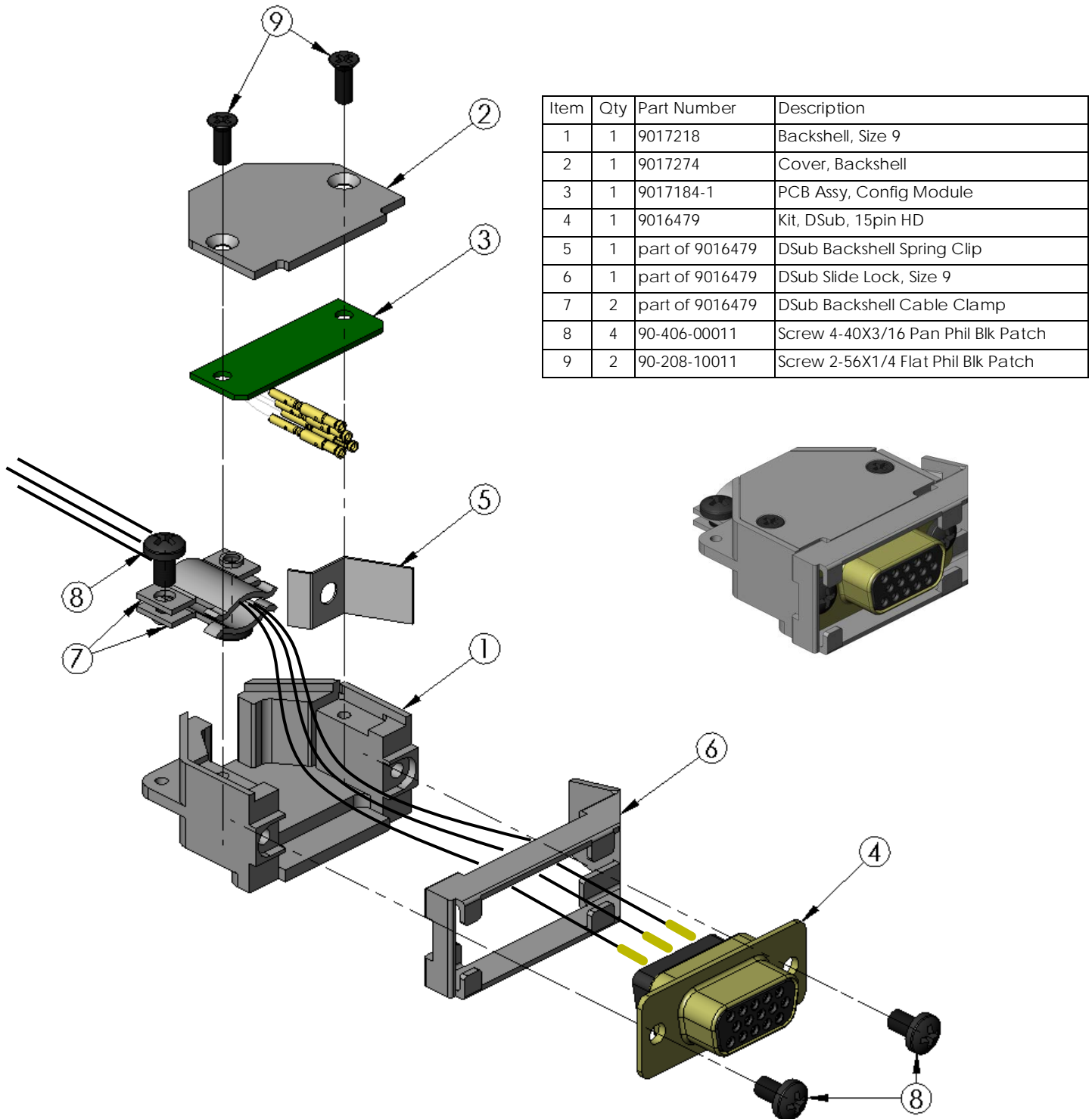

**FIGURE 2.3
CONFIGURATION MODULE ASSEMBLY**

2.6 PITOT / STATIC CONNECTIONS

The connector kit supplied with the unit contains two (2) pneumatic quick disconnect fittings. These fittings are specific to the connections on the rear of the unit and required for proper operation.

Aircraft tubing that connects to the unit must be ¼" OD with an approximate 0.17" ID. When determining tubing length, be sure that it can extend through the cutout in the panel by approximately 8" to allow the unit to be installed and removed from the front of the panel.

NOTE: It is helpful to identify/label each tube (pitot or static) so that it can be connected to the correct port on the back of the unit during installation.

2.7 MOUNTING

The MD302 is designed primarily to be front mounted in an aircraft instrument panel. Refer to Section 2.5 in regards to Equipment Location. To install the unit in the instrument panel, follow the instructions below and refer to Figures 2.4, 2.5 and 2.6.

- 1) Once a location is selected, cut the panel per the dimensions in Figure 2.5. Other notes to consider for panel cutout: (the Nutplate can be used as a basic template for the panel cutout)
 - For vertical installation, rotate the panel cutout profile 90°.
 - Be sure to leave space clear on the front of the panel for the bezel of the unit, which will extend significantly outside the main rectangular cutout.
 - The dimension of the smaller side of the rectangle is critical for a good finished appearance. If it is too large, the cutout will be visible outside the unit bezel. The relationship of the holes to the cutout should be maintained closely to ensure proper installation.
 - One countersink hole on either side of the rectangular cutout is required. Any of the three hole locations is acceptable. More than one countersink hole on each side is optional. Screws for these holes will retain the Nutplate and not support the weight of the unit.
 - Verify that a flathead screw will sit flush or below the panel surface in the countersink holes. If not, deepen the countersinks slightly.
 - Remove burrs around the cutout and holes to allow the unit to mount flush with the panel.
- 2) Install the Nutplate on the backside of the instrument panel using at least one (1) flathead screw on each side of the rectangular cutout.
 - The Nutplate should mount flush to the backside of the instrument panel. The threaded nuts in corners of the Nutplate should protrude to the rear.
- 3) Route the prepared cable harness and pitot/static fittings from behind the panel and through the panel cutout. The length of the cable harness should allow the unit to be connected in front of the panel.
- 4) VERIFY THAT AIRCRAFT POWER IS TURNED OFF.
- 5) Connect the cable harness with configuration module and pitot/static fittings to the rear of the unit.
- 6) Insert the unit through the panel cutout and secure with four (4) hex cap screws provided.
 - Electrical bonding between the aircraft and the unit chassis is NOT required.

2.8 INSTALLATION COMPLETION

Prior to operating the unit in the aircraft, verify the basic operation of the unit and conduct a standard leak check of the pitot/static system per the aircraft maintenance manual or industry practice. When initially powering the unit, an error may occur if a pre-configured unit is being mated to a Configuration Module for the first time or if the unit has yet to be configured. Acknowledge this error and either proceed to configuring the installation settings or cycle the power. The error should not occur for subsequent startups.

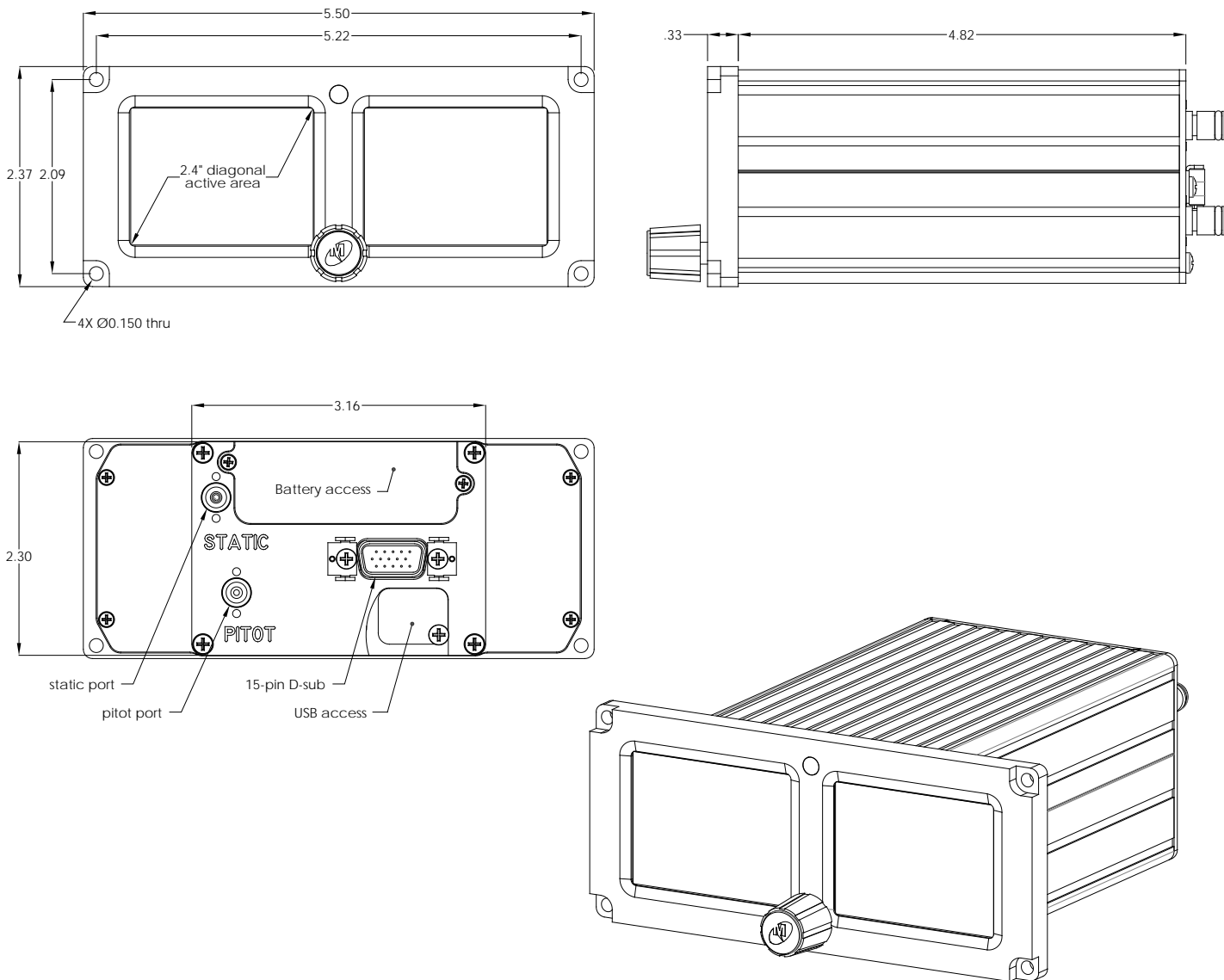

SAM™

Standby Attitude Module

FIGURE 2.4
MD302 OUTLINE DRAWING

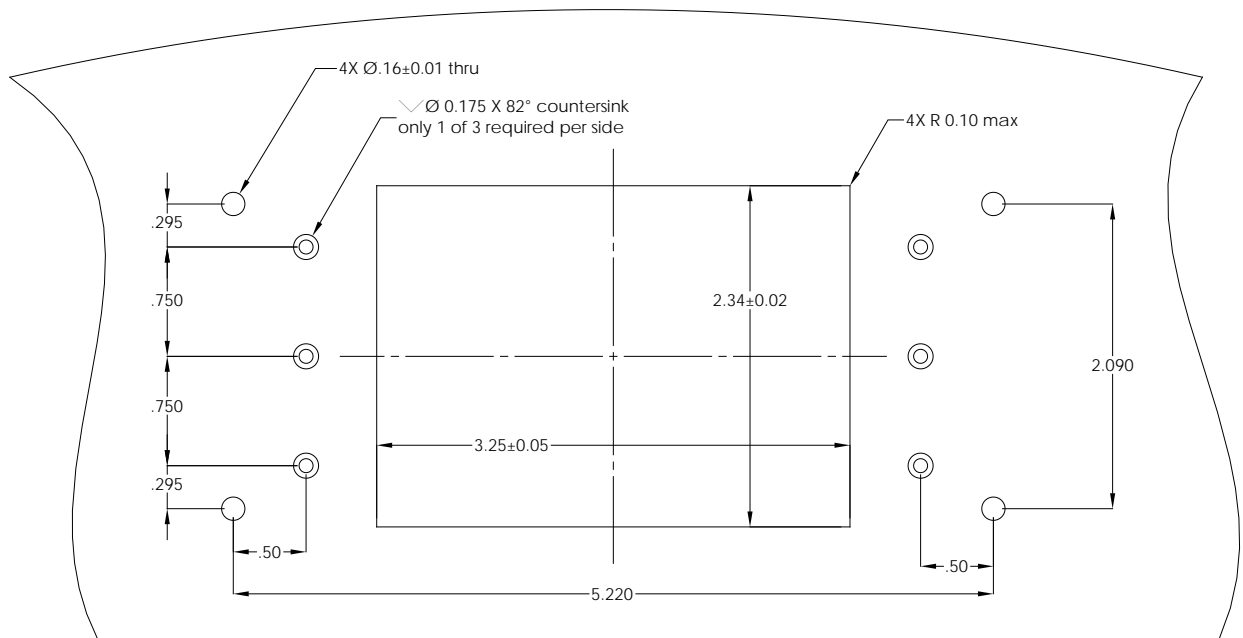

**FIGURE 2.5
PANEL CUTOUT**

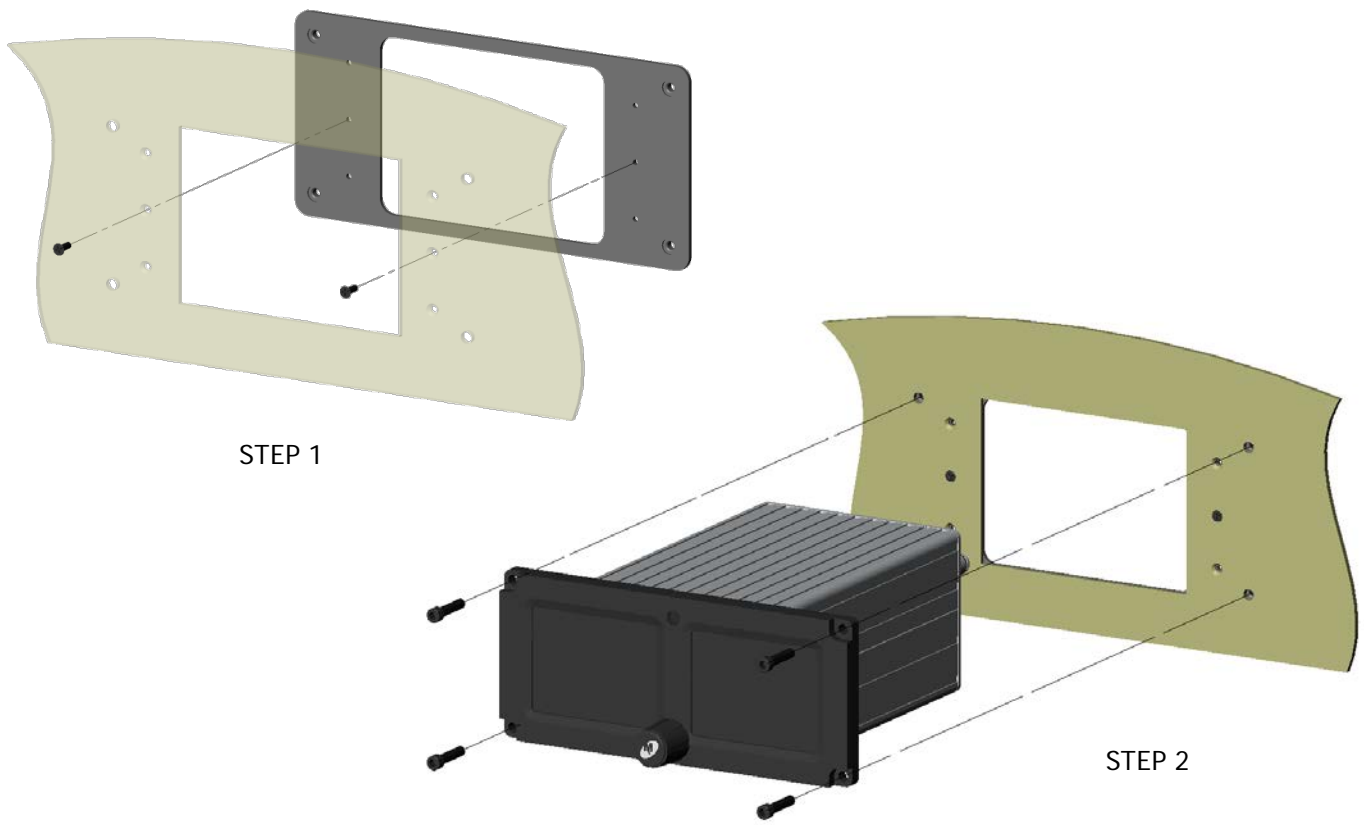

**FIGURE 2.6
INSTALL ILLUSTRATION**

SECTION 3 OPERATION

IMPORTANT: READ THIS ENTIRE SECTION PRIOR TO OPERATING THE UNIT IN FLIGHT!

This section contains information on how to use and interpret the information presented to the pilot and crew during normal and emergency operation of the MD302 Digital Flight Instrument.

3.1 USER INTERFACE

The MD302 Digital Flight Instrument is designed for simple, intuitive operation for ease of use and quick interpretation of the information displayed.

The central control knob can be located at the bottom-center, middle-left or middle-right of the unit bezel depending on the installation orientation. This is the only user interface device on the unit.

The knob has two functions: push and turn.

- The knob provides 16-detents per revolution and typically increments whatever element it is controlling on the display one unit per detent.
- The push function is typically used to select the highlighted option in menus and/or to enter and exit menus and control functions. The push function can also perform certain operations with a push-and-hold action as described herein.

3.2 PRE-FLIGHT MODE

In Pre-flight Mode, power is applied to the unit and the introduction screen appears during startup with the information shown in Figure 3.1.

During Pre-flight Mode, the startup screen shown in Figure 3.1 will be displayed while the unit conducts an initial power-up built-in test (PBIT) of the system to validate operational readiness. This includes, among others, a battery capacity measurement, an internal checksum to verify software and memory, and a check that the internal settings and identification of the unit match the Configuration Module installed in the aircraft cable harness.

The startup screen will be displayed for approximately 5 seconds and will transition to Flight Mode when complete.

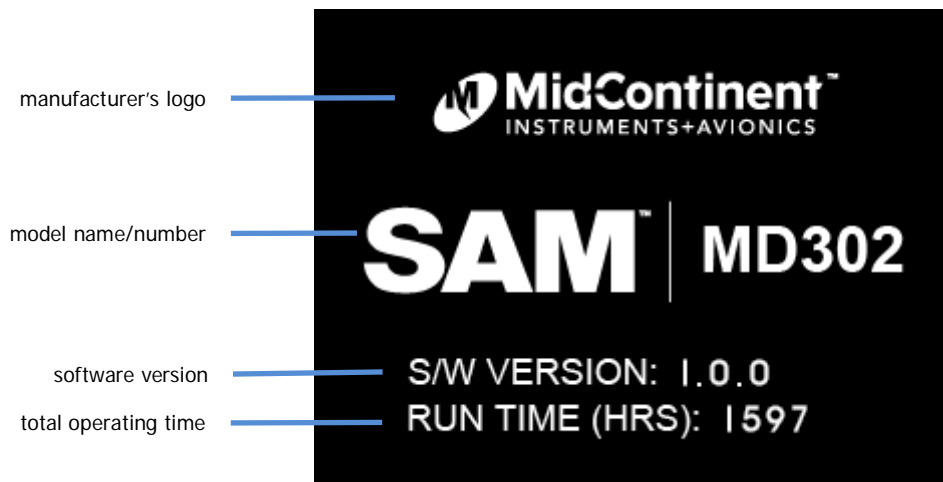

FIGURE3.1



FIGURE 3.1 (cont)
PRE-FLIGHT MODE

3.3 FLIGHT MODE

In Flight Mode, the unit operates normally by displaying the four major functions of attitude, altitude, airspeed and slip information as shown in Figure 3.2. The Options Menu and brightness adjustment are also accessible in Flight Mode.

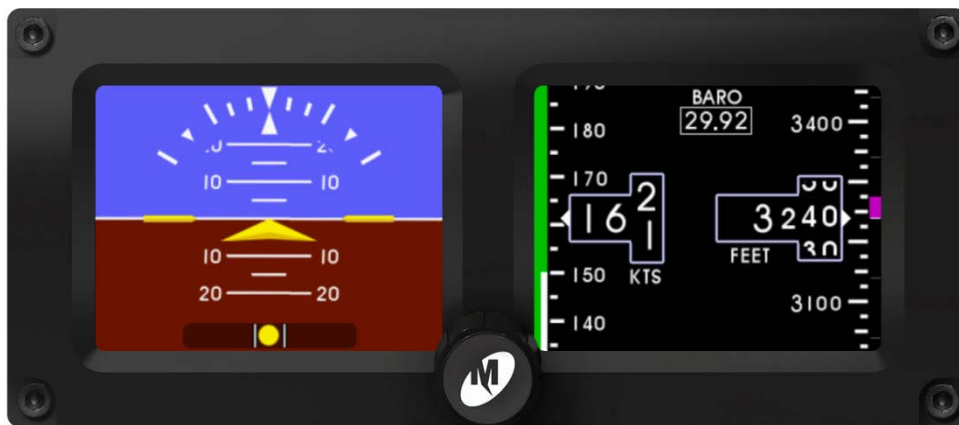

FIGURE3.2

3.3.1 MAJOR FUNCTIONS

While in Flight Mode, the MD302 provides four major functions: attitude, altitude, airspeed and slip indication.

3.3.1.1 ATTITUDE OPERATION

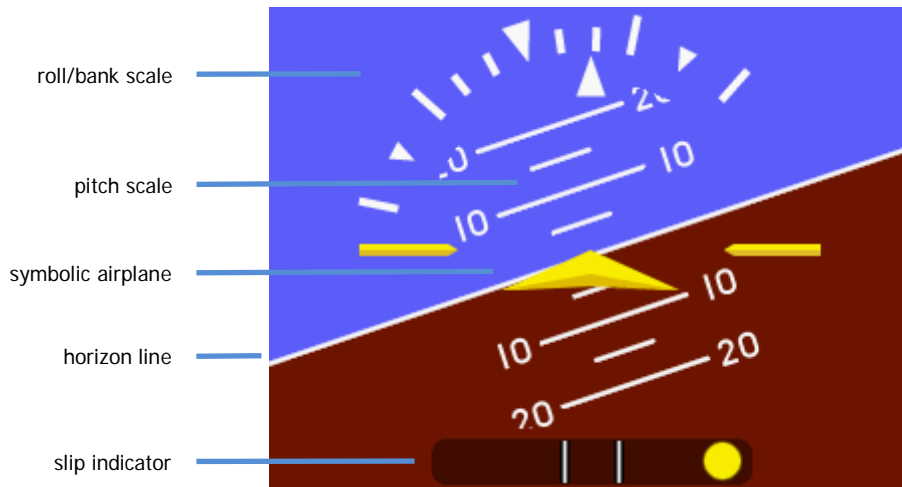

FIGURE 3.3

The attitude indicator portion of the display will always appear on the left display when the unit is oriented horizontally and on the top display when oriented vertically. An example of the attitude display is shown in Figure 3.3.

The background of the display consists of the representative white horizon line separating the 'sky' (blue) and 'ground' (brown).

The roll scale is depicted as an arc of graduations representing bank angles of 0 (triangle), 10, 20, 30, 45 (small triangle), and 60. The roll scale can be configured during installation to be fixed to the sky/horizon or fixed to the top of the display. See Section 3 for how to configure this option. The unit is operable and usable in a continuous and unlimited roll range of 360°+.

The roll pointer is the triangle just below the roll scale and represents the aircraft in relation to its bank angle. It is configured, by definition, to operate conversely to the roll scale behavior. That is, a rotating roll scale produces a fixed roll pointer and a fixed roll scale produces a rotating roll pointer.

The pitch scale is depicted as a series of graduations representing pitch angles of every 5°, with every 10° graduation extended and numbered. The unit is operable and usable in a continuous and unlimited pitch range of 360°+. A series of chevrons (^) will appear overlaid on the pitch scale as seen in Figure 3.4. This is to indicate to the pilot the direction of the horizon for quick reference when in unusual pitch attitude.

The symbolic airplane will always remain in the center of the display, with the background elements moving behind it to represent the aircraft's relative position. The symbol that represents the airplane can be selected during Flight Mode using the Options Menu (see Section 3.3.2).

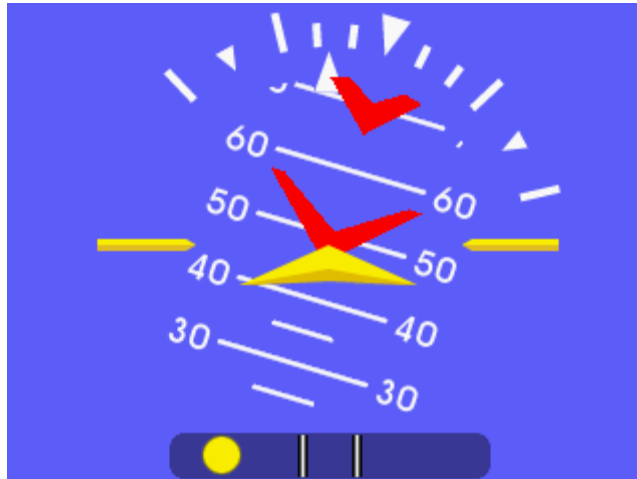

FIGURE 3.4

3.3.1.2 ALTITUDE OPERATION

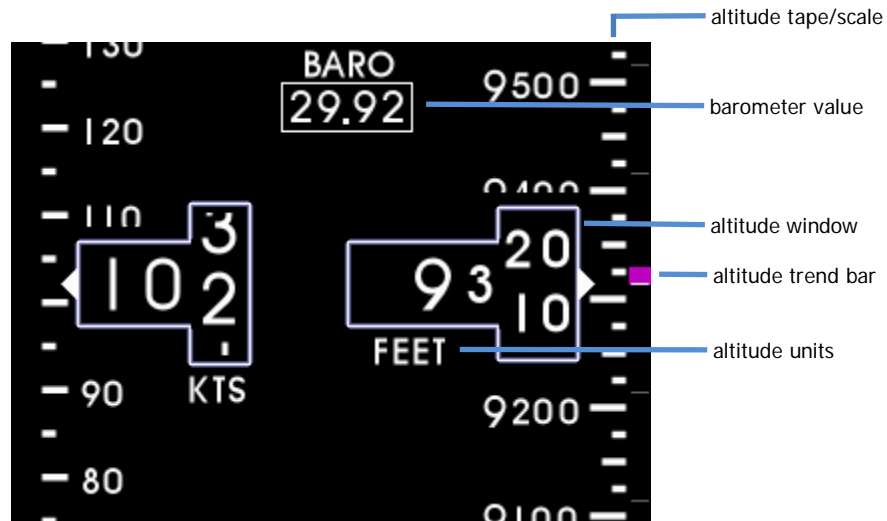

FIGURE 3.5

The altimeter or altitude portion of the display will always appear on the right side of the right display when mounted horizontally and on the right side of the bottom display when mounted vertically. An example of the altitude display is shown in Figure 3.5.

The altimeter consists of four parts: the altitude window, the altitude tape, the barometer window, and the optional altitude trend bar.

The altitude window displays the current, barometric adjusted altitude. The indicated digits of the display are every ten (10) units and the window is expanded over this portion of the number to display a minimum of (20) units. The units will 'roll' or scroll to assist in quick reference as to the increasing or decreasing nature of the aircraft's altitude. The hundreds, thousands and ten-thousands digits appear to the left of the tens digits with the thousands and ten-thousand digits slightly larger than the others. The altitude pointer (triangle) to the right of the window points to the associated position on

the altitude tape of the current altitude. Altitude units appear below the altitude window and can be changed during Flight Mode using the Options Menu (see Section 3.3.2).

The altitude tape is a vertical scale along the right margin of the display. The current altitude is always in the middle of the tape and indicated by the triangular pointer on the right side of the altitude window. The tape has numeric indications every one-hundred (100) units with minor graduations every fifty (50) units and sub-graduations every twenty-five (25) units. In horizontal installations, the tape spans approximately 400 units from top to bottom and in vertical installations, the tape spans approximately 500 units from top to bottom. The tape will 'roll' or scroll to assist in quick reference as to the increasing or decreasing nature of the aircraft's altitude.

The barometer window shows the currently set barometric pressure, is identified by the abbreviation "BARO" and is located at the top center of the airspeed/altitude display. Setting the current barometric pressure compensates the altitude for the appropriate environmental conditions. The barometric setting can be adjusted with a simple turning of the control knob while in Flight Mode. When adjusting the barometric pressure, the window will increase in size and the digits will turn green. When finished setting the pressure, the window will return to its original size and color. Barometric pressure units can be selected during Flight Mode using the Options Menu (see Section 3.3.2).

The altitude trend bar is located along the right margin of the altitude display. This feature is optional and can be turned on or off using the Options Menu (see Section 3.3.2). The trend bar is magenta in color and originates at the current altitude on the altitude tape (always from the middle of the display, directly across from the altitude pointer). The height of the trend bar, above or below the current altitude, indicates the altitude of the aircraft on the altitude tape if the current vertical speed or 'altitude trend' is maintained over a period of six (6) seconds. For example, in Figure 3.5, the current altitude is approximately 9,315 feet. The trend bar is at approximately 9,325 feet, indicating that the aircraft's altitude will be 9,325 feet in 6 seconds if the current vertical speed or climb is maintained constant. The length of the trend bar will increase with increased dive or climb rates and approach zero or disappear entirely as the vertical speed reaches zero in level flight.

3.3.1.3 AIRSPEED OPERATION

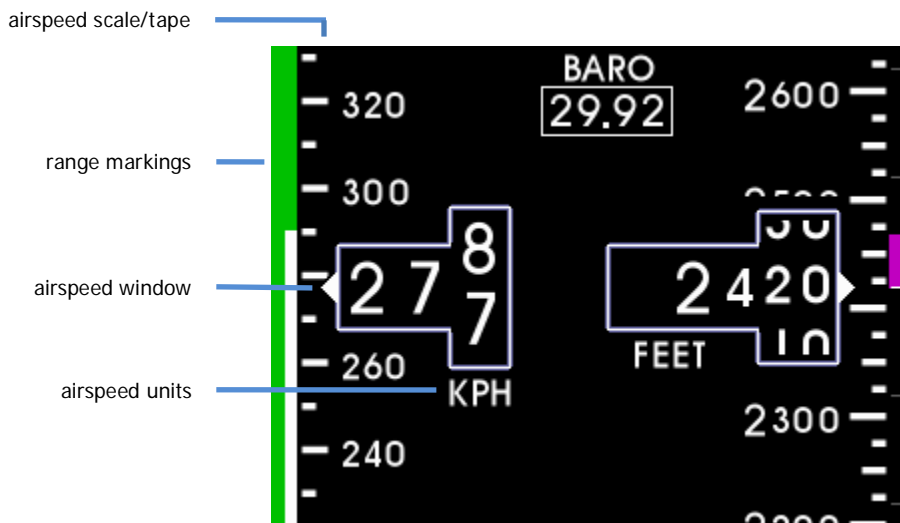

FIGURE 3.6

The airspeed indicator portion of the display will always appear on the left side of the right display when mounted horizontally and on the left side of the bottom display when mounted vertically. An example of the airspeed display is shown in Figure 3.6.

The airspeed indicator display consists of three parts: the airspeed window, the airspeed tape, and the airspeed limitations or range markings.

The airspeed window displays the current indicated airspeed (IAS). The digits of the display are enlarged for visibility and increment by one (1) unit. The units will 'roll' or scroll to assist in quick reference as to the increasing or decreasing nature of the aircraft's airspeed. The airspeed pointer (triangle) to the left of the window points to the associated position on the airspeed tape of the current airspeed. Airspeed units appear below the airspeed window and can be selected during installation in Configuration Mode (see Section 4).

The airspeed tape is a vertical scale along the left margin of the display. The current airspeed is always in the middle of the tape and indicated by the triangular pointer on the left side of the airspeed window. The tape has numeric indications every ten (10) or twenty (20) units depending on the unit type selected. Minor graduations appear every five (5) or ten (10) units, respectively. In horizontal installations, the tape spans approximately 50 or 100 units from top to bottom and in vertical installations; the tape spans approximately 80 or 160 units from top to bottom depending on unit type. The tape will 'roll' or scroll to assist in quick reference as to the increasing or decreasing nature of the aircraft's airspeed.

The airspeed limitations, also known as "V-speeds", are indicated with colored range marking bands placed vertically along the left margin next to the airspeed tape. The colors and values of each bar can be set during installation in Configuration Mode (see Section 4). Colors should be selected based on industry-defined colors and V-speed limits as defined by the aircraft's specific Pilot's Operating Handbook (POH). Range markings can be represented by full-width bars, half-width bars and/or radial marks. A traditional 'barber pole' may also be displayed if the aircraft requires and provides, the appropriate Vmo and/ or Mmo values.

3.3.1.4 SLIP OPERATION

The slip indicator portion of the display will always appear at the bottom of the attitude display. An example of the slip indicator is shown in Figure 3.3.

The slip indicator is represented by a shaded translucent background with two white lines around center and a yellow ball. The ends of the indicator represent $\pm 7^\circ$ of bank with no centripetal acceleration. No further indication is provided for angles greater than 7° . When the ball is maintained between the vertical lines during banking maneuvers, the turn is considered "coordinated" without slip. Electronic damping of the ball movement is provided to prevent overly sensitive response and comply with regulatory requirements.

The slip indicator background becomes semi-transparent if the roll scale or roll pointer pass behind the indicator so that all elements are still visible.

3.3.2 OPTION SETTINGS

While in Flight Mode, aOption Settings menu is available to the pilot or cockpit crew members. The Option Settings offer multiple options that do not affect the aircraft specific configuration of the unit (these must be set in Configuration Mode by authorized personnel during installation and/or maintenance). They are provided for convenience, preference or potentially necessary in-flight adjustments.

The Option Settings menu can be accessed by pushing and holding the control knob for approximately two (2) seconds. The brightness adjustment bar will appear briefly before the menu is visible. The menu will appear in place of the attitude display and will revert to the active attitude indicator if no activity occurs for ten (10) seconds.

The Option Settings root menu contains the following options: (as shown in Figure 3.7)

- ALT UNITS
- BARO UNITS
- SYMBOL
- ATT MASK
- ALT TREND
- POWER OFF
- REVIEW CONFIG
- EXIT MENU

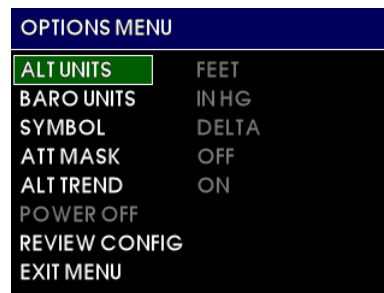

FIGURE 3.7

3.3.2.1 MENU OPERATION

The menu parts are defined below:

- Menu title – white text on a blue background at the top of each menu and sub-menu
- Current item cursor – highlighted by a white box and green background
- Selectable items – any selectable item on the menu is indicated in white text
- Unavailable items – information only / unavailable options are indicated with gray text

Menu operation throughout the MD302 is simple and intuitive:

Turning the control knob will scroll the green cursor highlight over the available options within the current menu. By default, the currently set value of each menu option is displayed in gray directly to the right of each setting. Pressing the control knob for any highlighted item will activate it and make its options available to the right. Scroll to the desired option and press the control knob to select it. The green highlight will return to the menu options on the left and the new value will be displayed in gray to the right.

After confirming any setting by selecting it, that setting will become active and be saved in memory, regardless of whether the EXIT MENU command is selected or it times out and automatically reverts to the attitude display.

3.3.2.2 ALT UNITS

The ALT UNITS setting allows the user to select the altimeter or altitude units to either FEET or METERS. This feature is provided during flight in the event that the aircraft crosses airspace boundaries that require or report different altitude units. See Figure 3.8.

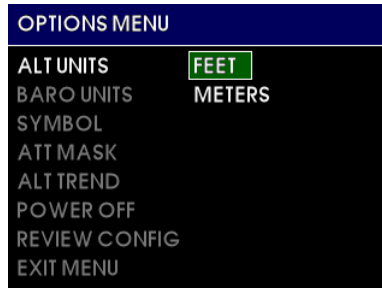

FIGURE 3.8

3.3.2.3 BARO UNITS

The BARO UNITS setting allows the user to select the altimeter or altitude barometric adjustment units to either inches of mercury (IN HG) or millibars (MBAR)/hectopascals (HPA). This feature is provided during flight in the event that the aircraft crosses airspace boundaries that require or report different barometric units. See Figure 3.9.

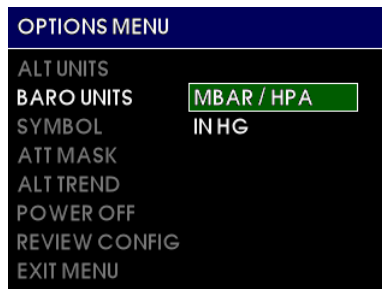

FIGURE 3.9

3.3.2.4 SYMBOL

The SYMBOL setting allows the user to select the type of symbolic airplane on the attitude display to either DELTA or TRADITIONAL. This feature is provided for pilot preference and/or to match other instruments in panel. See Figure 3.10.

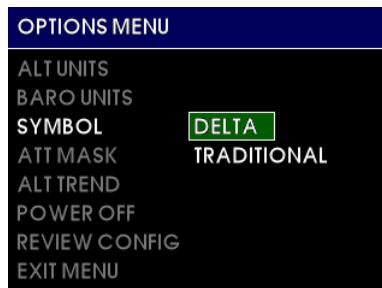

FIGURE 3.10

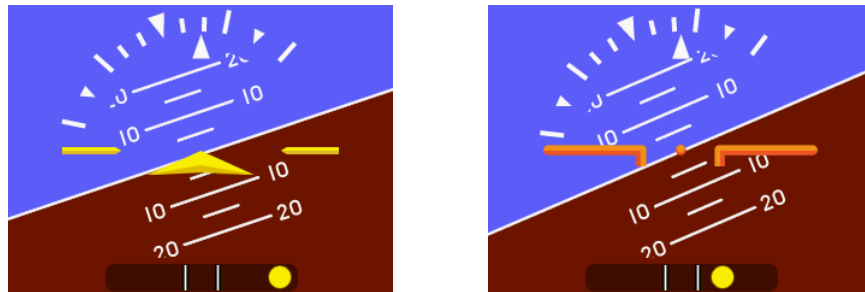

FIGURE 3.11

3.3.2.5 ATT MASK

The ATT MASK setting allows the user to turn the attitude mask ON or OFF. The attitude mask provides gradient dimming of the corners of the attitude display to give the aesthetic look of a round instrument. See Figure 3.12 and 3.13.

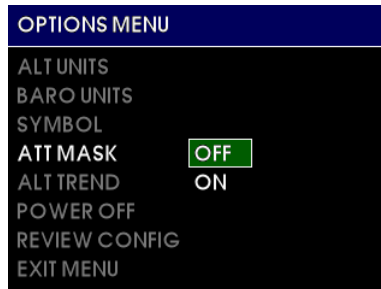

FIGURE 3.12

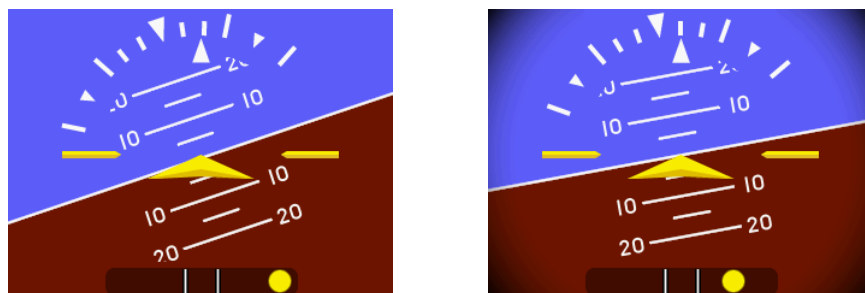

FIGURE 3.13

3.3.2.6 ALT TREND

The ALT TREND setting allows the user to turn the altitude trend bar ON or OFF. The altitude trend bar provides a graphical representation of vertical speed near the altitude tape (see Section 3.3.1.2). This feature is provided for pilot preference and/or convenience. See Figure 3.14.

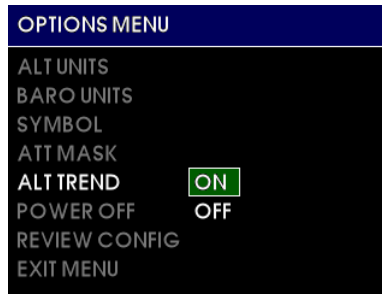

FIGURE 3.14

3.3.2.7 POWER OFF

The POWER OFF action allows the user to immediately turn the unit off when it is operating on its internal battery and there is no significant motion or airspeed detected. There are no selectable options. This item is typically grayed out and unavailable in flight mode. This feature is provided to turn the unit off when on the ground and/or if inadvertently left on battery power. See Section 3.4 for more information on Emergency Operation when operating on battery power. See Figure 3.15.

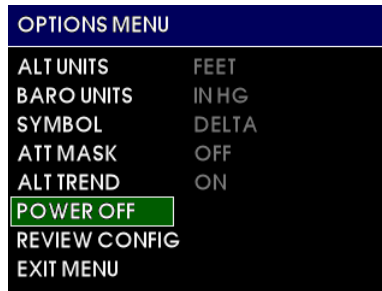

FIGURE 3.15

3.3.2.8 REVIEW CONFIG

The REVIEW CONFIG action allows the user to view all the values which are saved in unit memory and are set in Configuration Mode during installation or maintenance. There are no selectable options and this feature provides a view-only verification of information only. When selected, a new menu (REVIEW CONFIG) will appear that allows the user to scroll through all the set values in the configuration menu. Push the control knob to return to the Options Menu. See Figure 3.16.



FIGURE 3.16

3.3.2.9 EXIT MENU

The EXIT MENU action allows the user to manually exit the Options Menu and return to the active attitude indicator display. There are no selectable options. After confirming any setting by selecting it, that setting will become active and be saved in memory, regardless of whether the EXIT MENU command is selected or it times out (approximately 10 seconds of inactivity) and automatically reverts to the attitude display. See Figure 3.17.

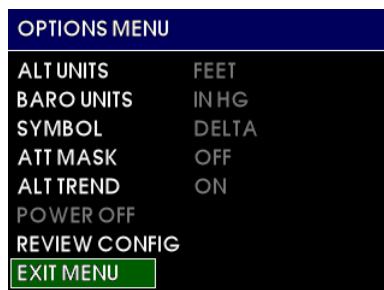

FIGURE 3.17

3.3.3 BRIGHTNESS ADJUSTMENT

The MD302 unit can be configured to adjust its brightness based on the aircraft's manual lighting bus control or automatically based on the ambient lighting conditions using the photocell sensor on the unit. For either option (selected in the Configuration Mode, see Section 4) the pilot or crew member can override the current brightness and manually increase or decrease it. To do this, briefly press the control knob. The brightness bar will appear overlaid on the attitude display and turning the control knob will increase or decrease the current setting.

While the unit remains powered, the manual adjustment will remain saved and any change in the lighting bus or photocell sensor will increase or decrease the brightness from the newly set manual adjustment.

When the unit is powered off, the manual adjustment will be reset and default to the lighting response curve programmed into memory per the settings in the Configuration Mode setup.

3.4 EMERGENCY OPERATION

3.4.1 IN FLIGHT

The MD302 is designed to operate reliably and provide the critical situational awareness needed even if the aircraft power systems fail. When this occurs, the unit provides emergency operation by continuing to perform seamlessly and uninterrupted in Flight Mode.

The MD302 contains an internal and field-replaceable True Blue Power® Nanophosphate® Lithium-ion battery which recharges during normal flight and provides a minimum of one (1) hour of operation and as much as 2.5 hours when new.

When primary aircraft power to the unit is lost in flight, the unit will immediately begin operating on internal battery power. This is indicated by a green battery icon displayed in the top right of the attitude display. See Figure 3.18.

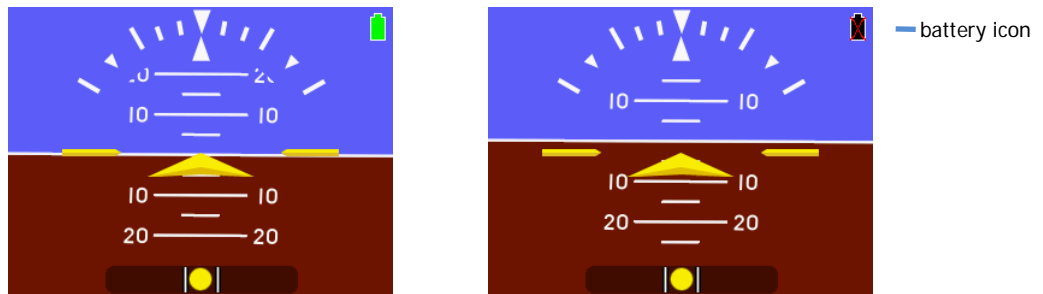

**FIGURE 3.18
EMERGENCY OPERATION**

When operating on battery power and it becomes low, the battery icon will change to the low battery icon. This is identified by a black battery icon with a red X on it. This indicates that there is less than 20% of battery capacity left and may represent as little as 10 minutes of backup power available. See Figure 3.18.

3.4.2 ON THE GROUND

When primary aircraft power to the unit is lost, the unit will immediately begin operating on battery power. If this occurs as a result of normal landing and shut-down procedures, the unit will recognize that there is no aircraft motion and no airspeed and determine that the aircraft is on the ground. Under these conditions, the unit will then display a warning message as shown in Figure 3.19. The unit will begin counting down for 60 seconds and then turn off automatically.

If continued operation is desired, press the control knob to select OK. If you want to turn the unit off after acknowledging the 'remain on' option, enter the Options Menu and select the POWER OFF action. See Section 3.3.2.1.

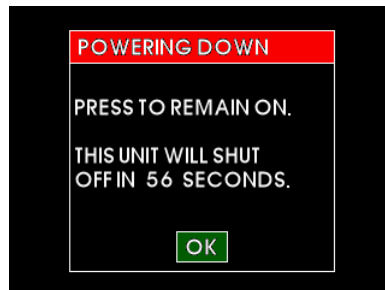

FIGURE 3.19

SECTION 4 CONFIGURATION SETUP

IMPORTANT: THE UNIT IS NOT APPROVED FOR FLIGHT UNTIL IT HAS BEEN CONFIGURED FULLY USING THE INSTRUCTIONS IN THIS SECTION!

This section contains information on how to configure the various requirements and options the MD302 Digital Flight Instrument offers in regards to the specific aircraft that it is installed in, including critical flight parameters that contributes to the safe and certified operation of the unit and the aircraft.

Several safeguards are in place to prevent a user from ever accessing the configuration mode while in flight. Only authorized installers and trained personnel should access the configuration mode during initial installation or during maintenance, adjustments and updates.

This section discusses the Configuration Mode/Menu completely and is organized into the following categories:

- Configuration Mode/Menugeneral usage and purpose
- Display Configuration
- Dimming Configuration
- Aircraft Configuration
- Configuration Mode Actions

4.1 CONFIGURATION MODE/MENU

In Configuration Mode, all of the parameters specific to the aircraft and particular installation are set and saved into permanent memory. These configuration settings are also saved to the external Configuration Module that is part of the aircraft's cable harness. This allows for the unit to be removed and/or replaced for service or other aircraft maintenance and still retain the configuration settings associated with the aircraft.

To enter the Configuration Mode, press and hold the control knob prior to applying power to the unit. After approximately six (6) seconds, the following message will appear: "CONTINUE HOLDING TO ENTER INSTALLER MODE".

After a few more seconds, the introduction screen will appear and the knob can be released. You will now see the CONFIGURE MENU as shown in Figure 4.1.

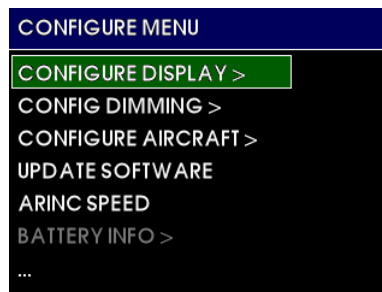

FIGURE 4.1

The CONFIGURE MENU root directory contains the following sub-menus and actions:

- CONFIGURE DISPLAY
- CONFIG DIMMING
- CONFIGURE AIRCRAFT
- UPDATE SOFTWARE
- ARINC SPEED
- BATTERY INFO
- POWER OFF
- ACCEPT CHANGES
- CANCEL CHANGES

The parts of the menu structure are defined below:

Menu title	white text on a blue background at the top of each menu and sub-menu
Current item cursor	highlighted by a white box and green background
Selectable items	any selectable item on the menu is indicated in white text
Unavailable items	information only / unavailable options are indicated with gray text
>	indicates an item has another menu page associated with it
...	indicates there are more options available past the bottom of the screen

Menu operation throughout the MD302 is simple and intuitive. See Section 3.3.2.1 for details.

NOTE: In Configuration Mode, unlike in the Options Menu, any changes made to any settings will not be saved unless you select ACCEPT CHANGES prior to exiting the Configuration Mode/Menu.

4.2 **CONFIGURE DISPLAY**

When the CONFIGURE DISPLAY menu option is selected, it opens the sub-menu shown below in Figure 4.2. Note the sub-menu title at the top of the screen and indication (>) that there is a parent menu associated with it. The EXIT CONFIG DISPLAY will return the user back to the CONFIGURE MENU.

Within the CONFIGURE DISPLAY sub-menu are the following options:

- ROLL DISPLAY
- AIRSPEED UNITS
- DISPLAY ORIENTATION
- EXIT CONFIG DISPLAY



FIGURE 4.2

4.2.1 ROLL DISPLAY

The ROLL DISPLAY setting allows the installer to select either the FIXED POINTER or FIXED SCALE option. With the FIXED POINTER, the roll scale containing the radial grads and triangles on the attitude display rotate with the horizon and the lower triangle pointer always points to the top of the display and represents the aircraft's position in relation to the scale. The FIXED SCALE (also known as 'sky pointer') option sets the roll scale stationary and allows the triangle pointer to rotate with the horizon. This feature should be selected to match other attitude instrument representations in the panel for consistency and reduced fatigue/work load on the pilot when switching field-of-view between instruments. See Figure 4.3 and 4.4.

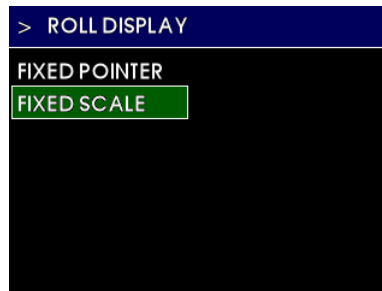

FIGURE 4.3

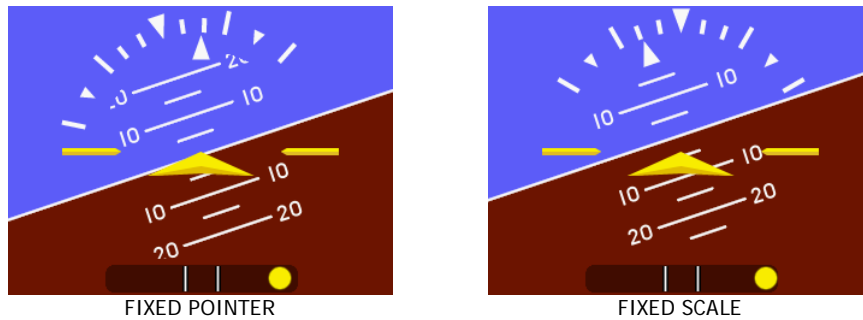

FIGURE 4.4

4.2.2 AIRSPEED UNITS

The AIRSPEED UNITS setting allows the installer to select the airspeed units to KNOTS, MPH (miles per hour) or KPH (kilometers per hour). This feature should be selected to match the other airspeed instrument representations in the panel for consistency and reduced fatigue/work load on the pilot when switching field-of-view between instruments. See Figure 4.5.

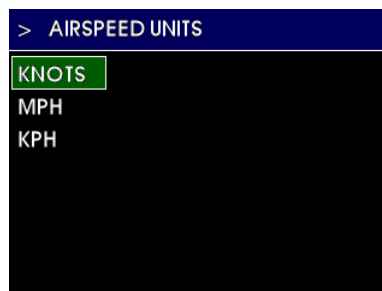

FIGURE 4.5

4.2.1 DISPLAY ORIENTATION

The DISPLAY ORIENTATION setting allows the installer to select the orientation that the unit will be installed in the panel. It can be installed HORIZONTAL, VERTICAL RIGHT, or VERTICAL LEFT. In the HORIZONTAL orientation, the unit must be installed with the control knob at the bottom of the unit. In the VERTICAL RIGHT orientation, the control knob is located on the right side of the unit. In the VERTICAL LEFT orientation, the control knob is located on the left side of the unit. See Section 2.3 Equipment Location when choosing the where and how to orient the unit in the aircraft instrument panel. This feature is provided for maximum installation flexibility but should be chosen carefully to fully comply with regulatory requirements which minimizes visual scan and is easily accessible. NOTE: in the vertical orientation, the location of the knob should be selected so that the pilot does not obstruct the display when operating the control knob. See Figure 4.6 and Figure 2.1.

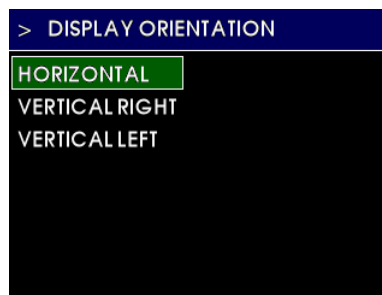

FIGURE 4.6

4.3 CONFIG DIMMING

The CONFIG DIMMING menu option opens the sub-menu shown below in Figure 4.7. Note the sub-menu title at the top of the screen and indication (>) that there is a parent menu associated with it. The EXIT DIMMING will return the user back to the CONFIGURE MENU.

Within the CONFIGURE DISPLAY sub-menu are the following options:

- DIMMING CONTROL
- DIMMING CURVE
- EXIT DIMMING



FIGURE 4.7

4.3.1 DIMMING CONTROL

The DIMMING CONTROL setting allows the installer to select the source of dimming control. It can be an external source, typically the aircraft's adjustable lighting bus, or it can use the INTERNAL photocell built into the unit which senses the ambient light conditions and adjusts the display brightness/dimming automatically. If an external source is to be used, the EXT 5V, EXT 14V, and EXT 28V options represent the input voltage range the unit will accept (0-5VDC, 0-14VDC, and 0-28VDC, respectively). This feature is provided for maximum installation flexibility and control for the pilot. See Figure 4.8.

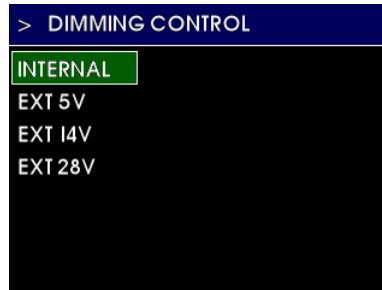

FIGURE 4.8

4.3.2 DIMMING CURVE

The DIMMING CURVE feature allows the installer to customize the response to the DIMMING CONTROL input, whether internal or external, over its range of operation. Therefore, for various points throughout the input range, the brightness can be adjusted up or down to produce a unique dimming scheme that most closely matches the other instruments in the panel and the pilot's preferences. This feature is provided for maximum installation flexibility and control for the pilot.

NOTE: When new, the display is daylight-visible at approximately 75% brightness. It may not be necessary to set the dimming curve to 100%. Setting the high-brightness side of the dimming curve to less than 100% will extend the life of the LED backlight and provide margin for the pilot to increase brightness as desired.

When setting the dimming curve with the dimming control set to INTERNAL, the X-axis of the dimming graph will read AMBIENT and will range from MIN to MAX. This represents the brightness of the light the unit's photocell can see and shows the current ambient light level with the vertical blue line. The Y-axis represents brightness of the display. It will track the dimming curve with the horizontal blue line as the input light increases or decreases. The best method for setting the dimming curve is to simulate the range of lighting conditions. This is best done after installation, in the actual aircraft instrument panel, but can be simulated in various environments. See Figure 4.9.

- 1) Change the light of the cockpit or general area around the unit until the vertical blue line matches (or nearly matches) the yellow highlighted point on the graph.
- 2) Adjust the control knob to increase or decrease the brightness of the display to the desired level at that lighting condition (the point will move up or down, respectively).
- 3) When satisfied, press the control knob.
- 4) The next point will be highlighted.
- 5) Repeat Steps 1-4 for each point on the graph.

When setting the dimming curve with the dimming control set to external input (EXT 5V/EXT 14V/ EXT 28V), the X-axis of the dimming graph will read VOLTAGE and will range from 0 to (5, 14 or 28). This represents the voltage input of the lighting bus and shows the current input with the vertical blue line. The Y-axis represents brightness of the display. It will track the dimming curve with the horizontal blue line as the input voltage increases or decreases. With a lighting bus input, the dimming curve adds a 'low-level output' feature. This allows the unit to be set to a high-brightness level to maintain daylight visibility when the lighting bus is turned down very low or off, as it may be during daylight hours. The best method for setting the dimming curve is to simulate the range of lighting inputs or conditions to match other instruments. This is best done after installation, in the actual aircraft instrument panel, but can be simulated in various environments. See Figure 4.10.

- 1) Change the lighting bus input until the vertical blue line matches (or nearly matches) the yellow highlighted point on the graph.
- 2) Adjust the control knob to increase or decrease the brightness of the display to the desired level at that lighting bus position (the point will move up or down, respectively).
- 3) When satisfied, press the control knob.
- 4) The next point will be highlighted.
- 5) Repeat Steps 1-4 for each point on the sloped line of the graph.
- 6) The next highlighted point will be on the vertical zero line. As the lighting bus is turned down or off, there may be a point where it should default to a set level (typically for daylight visibility). Adjust this dot horizontally with the control knob to set the low-input level of the lighting bus where the default brightness takes effect. You can verify where this occurs by adjusting the lighting bus input. Press the control knob to accept the position chosen. If this point is not set, the display will follow the dimming curve previously programmed and will respond to the position of the first point when the lighting bus is turned off.
- 7) The next highlighted point will set the default low-input brightness. With the lighting bus input to the left of the previous set point, adjust the brightness up or down to the desired level. Press the control knob to accept the position chosen.

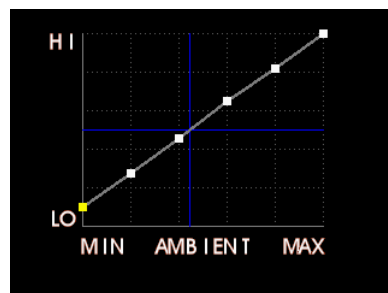

FIGURE 4.9

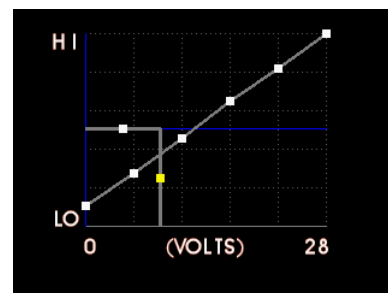

FIGURE 4.10

4.4 CONFIGURE AIRCRAFT

The CONFIGURE AIRCRAFT menu option opens the sub-menu shown below in Figure 4.11. Note the sub-menu title at the top of the screen and indication (>) that there is a parent menu associated with it. The CONFIGURE AIRCRAFT will return the user back to the CONFIGURE MENU.

Within the CONFIGURE AIRCRAFT sub-menu are the following options:

- PANEL TILT
- RANGE MMO
- RANGE MARKINGS
- EXIT CONFIG AIRCRAFT

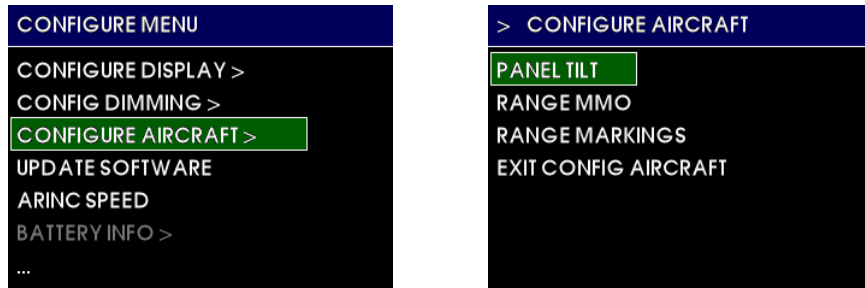

FIGURE 4.11

4.4.1 PANEL TILT

The PANEL TILT setting allows the installer to input the angle of the instrument panel so that the attitude indicator will show zero pitch when in level flight. Use the control knob to change the value of each panel tilt digit and press the control knob to acknowledge each selection and advance to the next one. See Figure 4.12.

NOTE: It is **extremely important** to measure and input the panel tilt angle accurately for proper operation of the unit. Panel tilt should be measured using a digital level or equivalent within $\pm 0.5^\circ$ when in level flight or as simulated on the ground. See the unit specifications for the total range of acceptable panel tilt angles.

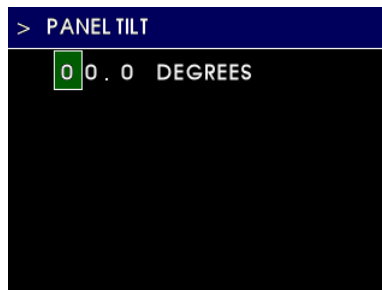

FIGURE 4.12

4.4.2 RANGE MMO

The RANGE MMO setting allows the installer to input the maximum operating Mach number specific to the aircraft. This is represented by a moving “barber pole” (red and white striped) color bar to the left of the airspeed tape that adjusts with varying airspeed and altitude. NOTE: THIS ONLY APPLIES TO AIRCRAFT WHICH PUBLISH A MAXIMUM OPERATING MACH NUMBER. The value should be zero for those aircraft which do not publish a maximum operating Mach number (M_{MO}). Use the control knob to change the value of each digit and press the control knob to acknowledge each selection and advance to the next one. See Figure 4.13.



FIGURE 4.13
MMO ENTRY PAGE AND SAMPLE SCREEN

4.4.3 RANGE MARKINGS

The RANGE MARKINGS setting allows the installer to input airspeed limits (or “V-speeds”) specific to the aircraft. Aircraft airspeed limits can typically be found in the Pilot’s Operating Handbook (POH). The range markings for airspeed limits appear as a series of colored bars to the left of the airspeed tape.

To program range markings: (See Figure 4.14)

- 1) Use the control knob to select the width of the color bar (H = Half, F = Full) and the desired color.
- 2) Press the control knob to accept the selection and move to the range values.
- 3) Turn the control knob to select each digit and press to move to the next digit.
 - a. The first three digits are the start or lower limit of the color bar range and the second three digits are the upper limit.
 - b. A ‘radial’ or tick-mark can be made at any value by selecting the Full (F) width and desired color, then setting the lower limit and upper limit to the same desired value.
 - c. The values automatically represent the units (knots, mph, kph) selected in the CONFIGURE DISPLAY > AIRSPEED UNITS menu.
- 4) Continue in sequence until reaching the EXIT prompt and press the control knob to exit the menu.
 - a. Leaving or selecting “000” for the lower and upper limit creates no color bar.

Note: Per AC 23.1311-1C, V_{NE} or V_{MO} aircraft should use Full Red color bars between 0 and V_{SO} and between V_{NE}/V_{MO} and the tape limit (500 knots or equivalent).

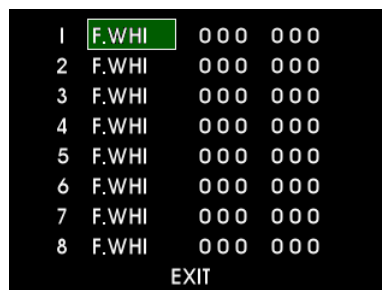

FIGURE 4.14

4.5 CONFIGURATION MODE ACTIONS

Configuration Mode Actions contain options that do not represent further sub-menus, but have single settings or initiate actions which exit the Configuration Mode. Figure 4.15 below shows the initial page of the Configuration Menu and the additional options at the bottom of the Configuration Menu page when scrolling down using the control knob.

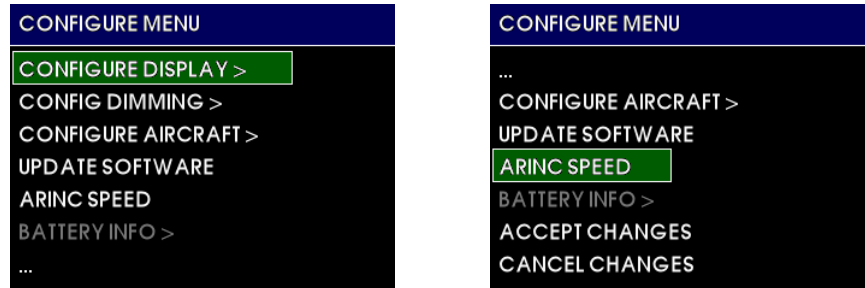

FIGURE 4.14

4.5.1 UPDATE SOFTWARE

The UPDATE SOFTWARE action initiates the unit to look for a software update that is present in a USB memory device that has been plugged into the rear of the unit. This action is unavailable in Emergency Mode (on battery power). If a USB device is not detected or a valid software update file is not found, a failure message will appear and return back to the Configuration Menu. If the unit finds a valid software update file, a software update progress screen will appear. The status screen will indicate when the software update completes successfully. Acknowledging this completion will automatically reset the unit and return to the Pre-flight Mode, followed by entering Flight Mode. See Figure 4.15.

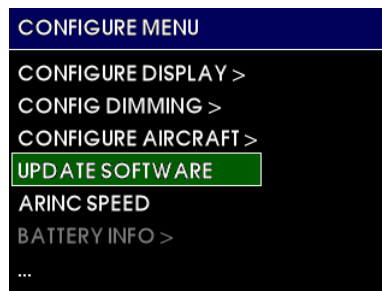

FIGURE 4.15

4.5.2 ARINC SPEED

The ARINC SPEED action presents the option to select either LOW or HIGH speed serial communication data. This option configures the unit's ability to output ARINC 429 communication data as listed in Table 1.4. Select the option which corresponds to the receiving equipment's capability in regards to data speed expectation. See Figure 4.16.

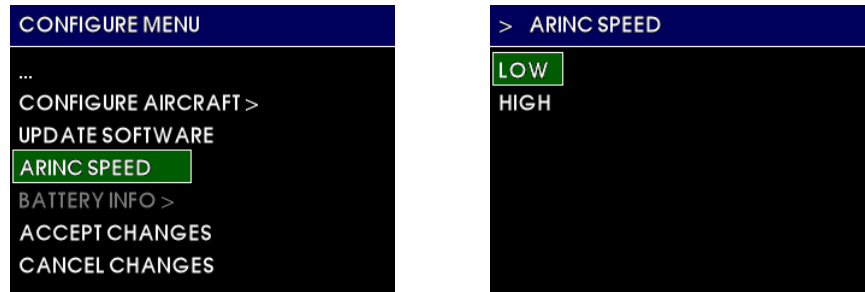

FIGURE 4.16

4.5.3 ACCEPT CHANGES

When selecting ACCEPT CHANGES, all settings and changes made while in Configuration Mode are saved into permanent memory and saved to the Configuration Module memory as well. SETTINGS WILL NOT BE SAVED UNLESS "ACCEPT CHANGES" IS SELECTED WHEN DONE. After selecting ACCEPT CHANGES, the unit will automatically reset and return to the Pre-flight Mode, followed by entering Flight Mode. See Figure 4.17.

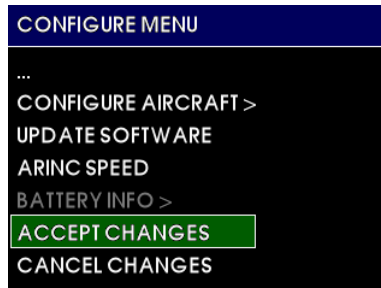

FIGURE 4.17

4.5.4 CANCEL CHANGES

When selecting CANCEL CHANGES, any settings or changes made while in Configuration Mode are canceled. ANY SETTINGS WILL NOT BE SAVED. After selecting CANCEL CHANGES, the unit will automatically reset and return to the Pre-flight Mode, followed by entering Flight Mode. See Figure 4.17.

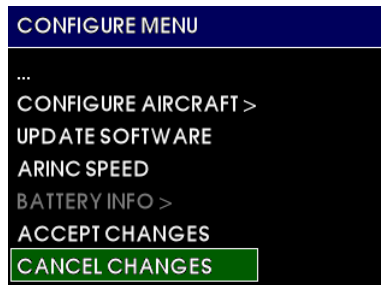

FIGURE 4.18

SECTION 5 CONFORMANCE

5.1 INSTRUCTIONS FOR CONTINUED AIRWORTHINESS

5.1.1 PRESSURE SYSTEM AND ALTIMETER VERIFICATION

Per federal regulation 14 CFR 91.411, it is required that each static pressure system and each altimeter have been tested and inspected within the last twenty-four (24) months.

5.1.2 SOFTWARE UPGRADES

Mid-Continent will have, on occasion the need to update software versions on the MD302 for maintenance, improvements and/or the addition of functionality.

With the MD302's easy field-upgrade option, the unit does not have to be returned to the factory, and in some cases, may not have to be removed from the panel.

Prepare the new software by loading it onto a USB memory device. It is recommended, but not necessary, that the USB device have no additional files on it. Loosen the screw on the back of the unit and insert the USB device. By following the procedures in Section 4.5.1, you can load your software into the MD302. Note the software version before and after this procedure which comes up on the initial Preflight screen.

5.1.3 BATTERY REPLACEMENT

There should be no regularly schedule maintenance of the True Blue Power Nanophosphate[®] lithium-ion battery. The battery will recharge itself from aircraft power while in normal mode. A battery capacity check occurs each time the unit is powered on. If the battery capacity is determined to be more than 80%, no message is displayed and the battery is good.

If a unit has a battery pack warning, and the warning persists more than once in a short time, it can be replaced in the field with minimal effort. By removing two small screws on the rear of the unit, the battery cover comes off, and the battery is accessible. Pull the battery out using the handle/strain relief built onto the battery. Replace with a new battery, verify operation and go.

5.1.4 TROUBLESHOOTING

The following Figures and associated descriptions represent warnings or errors and describe the typical reasons and appropriate response action.



FIGURE 5.1

The attitude display has failed due to exceedance of interal rate sensors, loss of airspeed or other various reasons. This will typically self-correct. However, if it does not, immediately have the unit serviced.

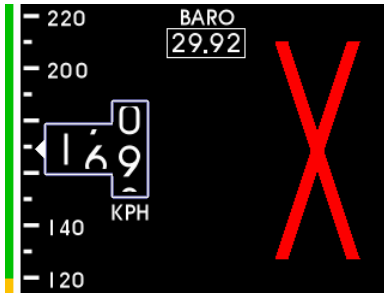

FIGURE 5.2

The altimeter instrument has failed, possibly due to exceedance of the pressure sensor range. This may self-correct, but if the error persists, immediately have the unit serviced.

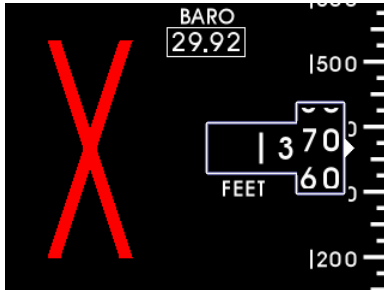

FIGURE 5.3

The airspeed instrument has failed, possibly due to exceedance of the pressure sensor range. This may self-correct, but if the error persists, immediately have the unit serviced.

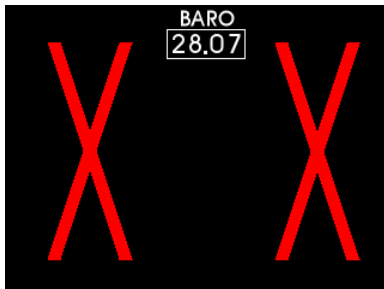

FIGURE 5.4

The airspeed and altimeter display have both failed due to exceedance of their respective sensor ranges. This may self-correct, but if the error persists, service unit immediately.

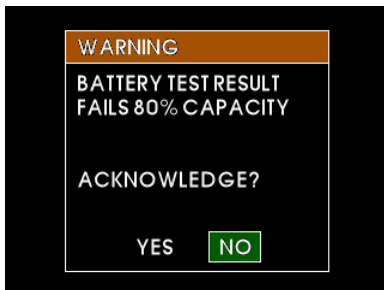

FIGURE 5.5

Battery failed initial capacity check. This may be due to recent battery usage without allowing time to recharge. This may also occur during extreme temperature conditions. User may acknowledge this error and continue operation, but available backup power capacity may be less than required minimum levels. If this warning persists, the battery will need serviced.

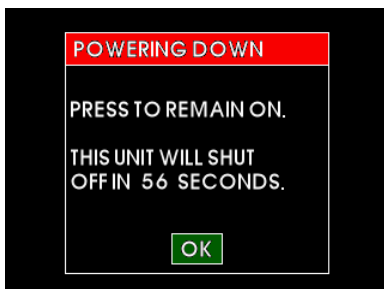

FIGURE 5.6

This message is displayed when power is removed at low airspeed (typical ground condition). The pilot has 60 seconds to confirm to remain on, otherwise the unit will automatically power off to conserve battery.

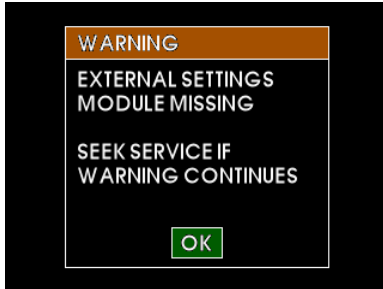

FIGURE 5.7

The configuration module has failed or is not installed properly. Internal settings will be used. If the configuration module is installed, it should be serviced immediately.



FIGURE 5.8

Internal failure. Service unit immediately.

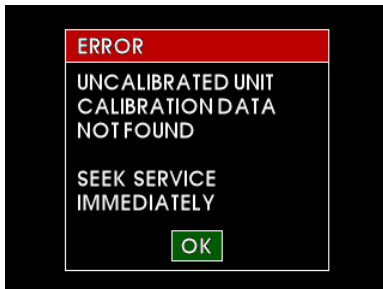

FIGURE 5.9

Internal failure. Service unit immediately.

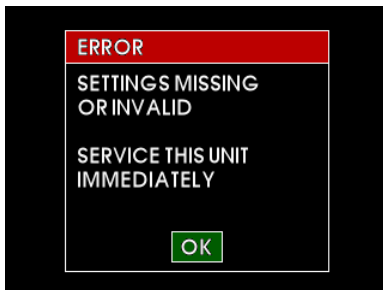

FIGURE 5.10

Internal (unit) and external settings (configuration module) failure. It is unlikely that both settings would be lost. Try to reconfigure the unit. Service unit if this error persists.

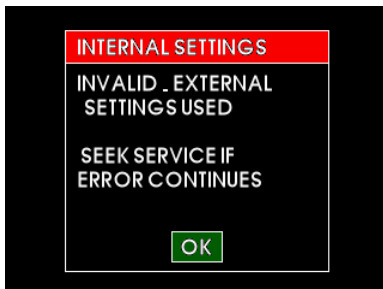

FIGURE 5.11

Internal (unit) settings were found to be invalid. The configuration module settings will be copied to internal memory. Service unit if this error persists.

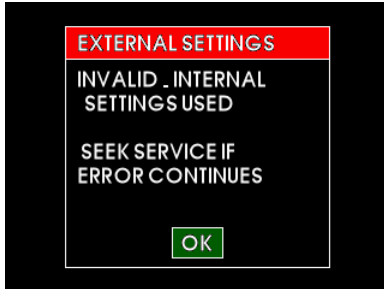

FIGURE 5.12

External settings (configuration module) were found to be invalid. The internal settings will be copied to the configuration module memory. Service unit if this error persists.

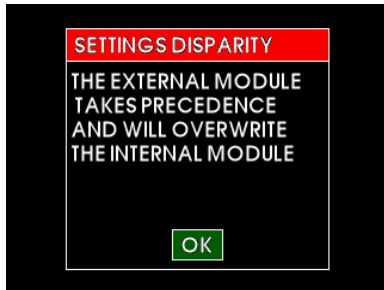

FIGURE 5.13

Internal (unit) and external (configuration module) settings were found to be different. This is typically the result of replacing a unit in an existing installation. The external settings will be copied to replace the settings in internal memory.

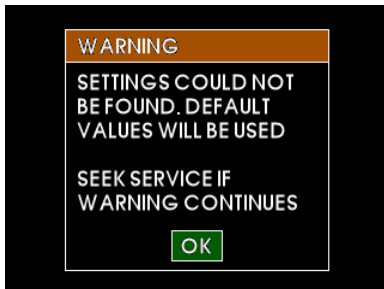

FIGURE 5.14

In configuration mode, this may be the result of lost settings both internally and externally. Try to configure the unit. Seek service if error persists.

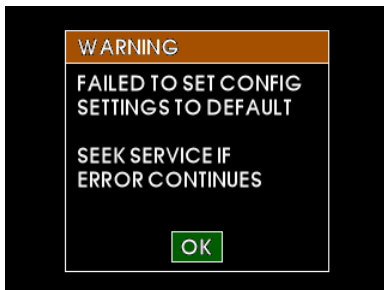

FIGURE 5.15

In configuration mode, this may be the result of lost settings and a failure to initialize memory. Try to restart and configure the unit. Seek service if error persists.

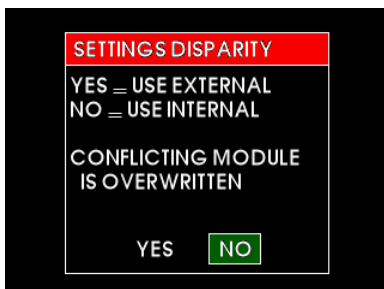

FIGURE 5.16

Internal (unit) and external (configuration module) settings were found to be different. This is typically the result of replacing a unit in an existing installation. In configuration mode, this choice allows selection of which settings to use.

5.2 ENVIRONMENTAL QUALIFICATION STATEMENT

NOMENCLATURE: 2-inch Standby Attitude Module
MODEL NUMBER: MD302 Series **PART NUMBER:** 6420302-()
TSO NUMBERS: C2d (Type B), C3e, C4c, C10b, C106, C113a, C179a
MANUFACTURERS SPECIFICATIONS:
 Minimum Performance Specifications: TS302 (XX/XX/XX), TDS302 (XX/XX/XX)
 Qualification Test Reports: QTR1201 (10/04/05)
MANUFACTURER: Mid-Continent Instrument Co., Inc.
ADDRESS: 9400 E. 34th St. North, Wichita, KS 67226, USA
RTCA DO-160: Rev G, dtd 12/08/10 **DATES TESTED:** 06/12-09/12

CONDITIONS	SECTION	DESCRIPTION OF TEST
Temperature and Altitude	4	Category F1
Low Temperature	4.5.1	Short and Normal Operating Low Temp = -30C
High Temperature	4.5.2	Short and Normal Operating High Temp = +70C
Decompression	4.6.2	Altitude = 55K
Overpressure	4.6.3	-15,000 ft
Temperature Variation	5	Category S2
Humidity	6	Category A
Operational Shock and Crash Safety	7	Category B
Vibration	8	Category R, Curves B, B1 (RBB1)
Explosion	9	Category X
Waterproofness	10	Category X
Fluids	11	Category X
Sand and Dust	12	Category X
Fungus	13	Category X
Salt Spray	14	Category X
Magnetic Effect	15	Category Z
Power Input	16	Category Z(XX)
Voltage Spike	17	Category A
Audio Frequency Conducted Susceptibility	18	Category Z
Induced Signal Susceptibility	19	Category ZC
Radio Frequency Susceptibility	20	Category W (conducted) Category F (radiated) [WF]
Emission of Radio Freq Energy	21	Category P
Lightning Induced Transient Susceptibility	22	Category B3 (pin injection) Category H33 (cable bundle) [B3H33]
Lightning Direct Effects	23	Category X
Icing	24	Category X
ESD	25	Category A
Fire, Flammability	26	Category X

REMARKS:

Sections 4: Category F1 complete with additional excursions as listed for Sections 4.5.1, 4.5.2, 4.6.2, and 4.6.3.